

1. Install the ice maker properly in accordance with the instructions on location water supply/drain connections and electrical connections stated in the instruction and installation manuals provided. Allow 10mm extra space at the installation site to meet any installation requirements (additional spacing is also required for proper air flow and pipe connections).
2. The ice production depends on the ambient and water temperatures. Refer to the instruction manual.
3. Product Code: M071-D003

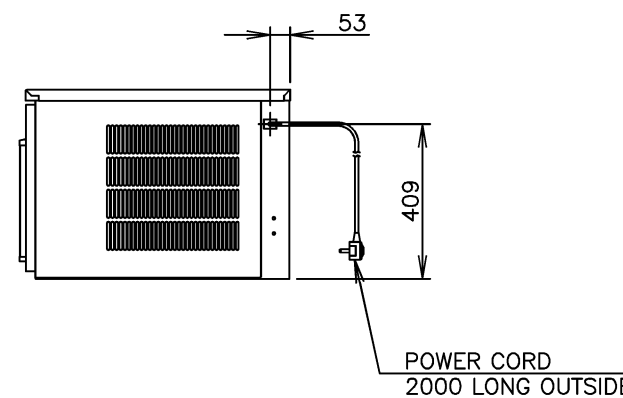
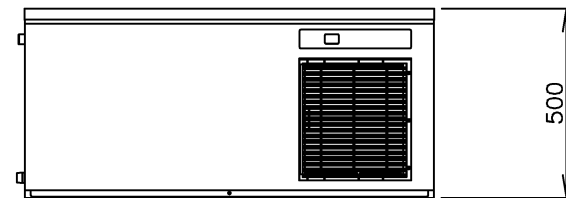
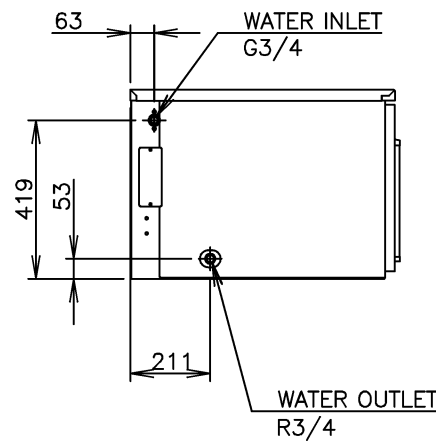
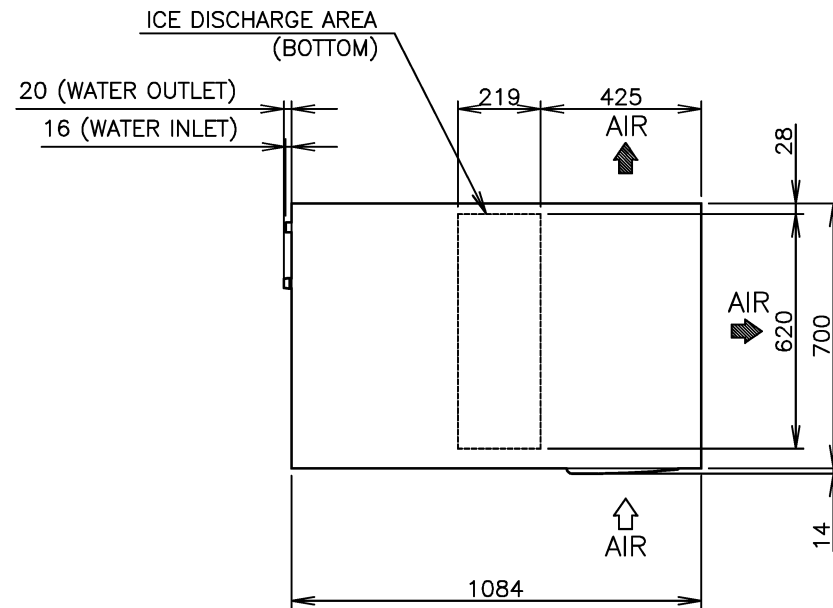

ITEM	Hoshizaki Cube Ice Maker	
MODEL	IM-240DNE-HC-32	
POWER SUPPLY	1 Phase 220-240V 50Hz Capacity: Min. 1.77kVA (7.4A)	
AMPERAGE	Running: 4.0A Rated Motor: 4.0A Starting: 27A	
ELECTRIC CONSUMPTION	Rated Motor: 930W (Power factor: 97%)	
ICE PRODUCTION PER 24h	Approx. 165kg(5mm)/190kg(15mm)(Ambient Temp.10° C Water Temp.10° C) Approx. 165kg(5mm)/175kg(15mm)(Ambient Temp.21° C Water Temp.15° C) Approx. 140kg(5mm)/145kg(15mm)(Ambient Temp.32° C Water Temp.21° C)	
WATER CONSUMPTION PER 24h	Approx. 0.53m ³ /d (Ambient Temp.10° C Water Temp.10° C) Approx. 0.31m ³ /d (Ambient Temp.21° C Water Temp.15° C) Approx. 0.26m ³ /d (Ambient Temp.32° C Water Temp.21° C)	
SHAPE OF ICE	Cube Approx 32 x 32 x 32mm	
FREEZE CYCLE TIME	Approx. 26min (Ambient Temp.21° C Water Temp.15° C)	
ICE PRODUCTION PER CYCLE	Approx. 3.3kg/108pcs (Ambient Temp.21° C Water Temp.15° C)	
OUTSIDE DIMENSIONS	1084mm(W) x 700mm(D) x 500mm(H)	
EXTERIOR	Stainless Steel	
INSULATION	Polyurethane Foam	
INSULATION FOAM BLOWING AGENT	Water Blown	
CONNECTIONS - ELECTRIC	X-Type Con. (with CONT. Plug)	
CONNECTIONS - WATER SUPPLY	Inlet G3/4 (connected at left side)	
CONNECTIONS-DRAIN	Outlet R3/4 (connected at left side)	
ICE MAKING SYSTEM	Cell type	
HARVESTING SYSTEM	Hot Gas Defrost	
COMPRESSOR	Hermetic	
CONDENSER	Fin and Tube type Air-cooled	
HEAT REJECTION	2330W(Ambient Temp.32° C Water Temp.21° C)	
EVAPORATOR	Electroless nickel plated Copper Tube on Sheet and Cells	
REFRIGERANT CONTROL	Thermostatic Expansion Valve	
REFRIGERANT CHARGE	R290/140g	
ICE MAKING CONTROL	Thermistor Timer	Controller Board
HARVESTING CONTROL	Thermistor	
BIN CONTROL	Microswitch (with Time Delay)	
ICE MAKING WATER CONTROL	Timer Water Pan's Movement	
ELECTRICAL PROTECTION	Class I Appliance 5A Fuse	
COMPRESSOR PROTECTION	Auto-reset Overload Protector	
ICE MAKER PROTECTION	Interlock by Controller Board	
WEIGHT	82kg (Gross 96kg)	
PACKAGE	Carton 1196mm(W) x 825mm(D) x 640mm(H)	
ACCESSORIES	Scoop Installation Kit Brace	
OPERATING CONDITIONS	Ambient Temp.: 1 - 40° C Water Supply Temp.: 5-35° C Water Supply Pressure: 0.07-0.8MPa (0.7-8bar) Voltage Range: Rated Voltage±6%	

*We reserve the right to make changes in specifications and design without prior notice.

HOSHIZAKI CUBE ICE MAKER IM-240DNE-HC-32

APPROVED YAMASAKI	CHECKED S.NOTSU	DESIGNED A.NAGASAWA	DRAWN OHASHI	SCALE 1/20	TRIGONOMETRY
*	*	△	*****	DATE 2018.12.07	DRAWING NO. D24103
APPROVED	DESIGNED	SYMBOL	DATE		SYMBOL △