

FOODSERVICE CATALOGUE

# REFRIGERATION. ICE MAKERS. SPECIALTY.

*The power of precision engineering  
and the intelligence of inspired design*



KITCHEN DESIGN MADE EASIER WITH  
BIM DATA ON [SPECIFIGLOBAL.COM](https://www.specifiglobal.com)



**HOSHIZAKI** |



**LEADING** NATURALLY





**HOSHIZAKI**

**GRAM**



CHARLOTTE'S W5, LONDON



LONDON AQUATICS CENTRE

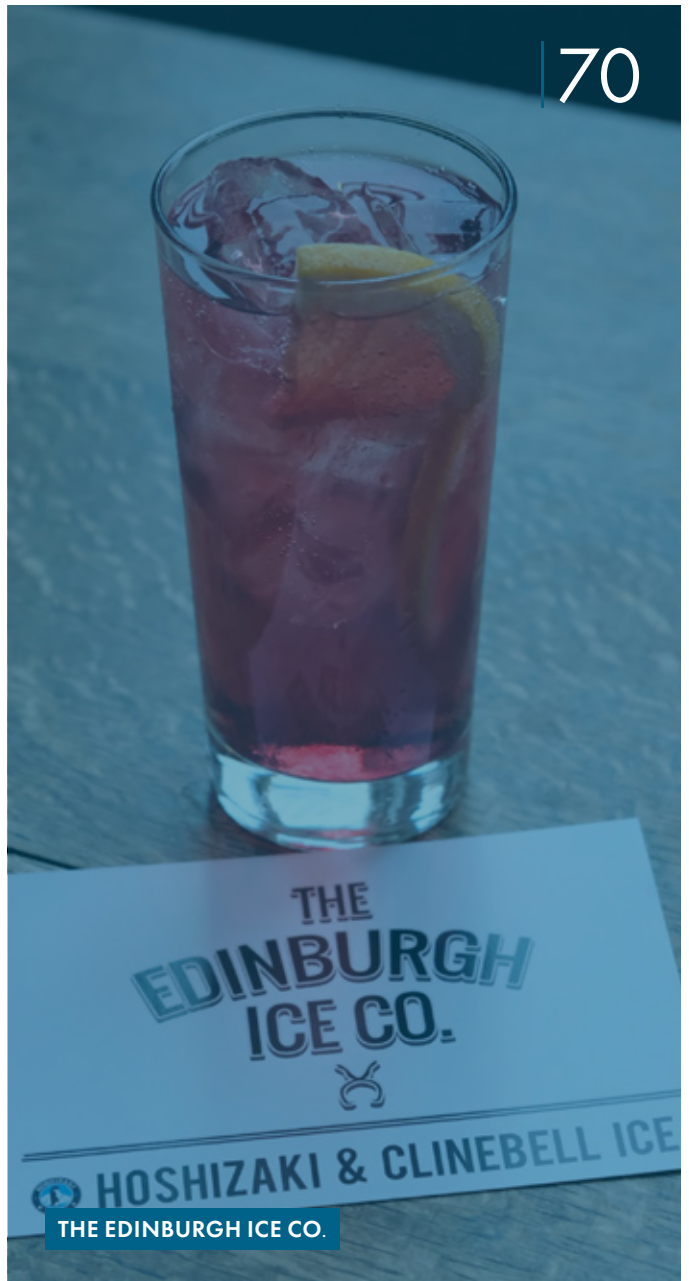

THE EDINBURGH ICE CO.



MIXOLOGY GROUP, BRIGHTON

## ABOUT US

- 6 HISTORY
- 8 SUSTAINABILITY
- 10 AFTER SALES

## STORAGE CABINETS

- 12 REFRIGERATION
- 14 GRAM SUPERIOR & ECO
- 16 GRAM SUPERIOR
- 18 GRAM ECO
- 20 GRAM STANDARD PLUS
- 22 GRAM COMPACT
- 26 GRAM ROLL-IN 1500

## STORAGE COUNTERS

- 28 **CASE STUDY** CHARLOTTE'S W5
- 30 GRAM GASTRO 07 & 08
- 32 GRAM GASTRO 07
- 34 GRAM GASTRO 08

## COOK & CHILL

- 36 GRAM KPS BLAST CHILLERS/FREEZERS
- 40 GRAM QUICK CHILLERS/FREEZERS

## SNOWFLAKE GII

- 42 SNOWFLAKE GII STORAGE CABINETS
- 44 SNOWFLAKE GII STORAGE COUNTERS
- 46 SNOWFLAKE BLAST CHILLERS/FREEZERS

## BAKERIES/PATISseries

- 48 REFRIGERATION & PROCESS
- 50 GRAM BAKER

- 52 GRAM STORAGE CABINETS & COUNTERS

- 54 GRAM PROCESS CABINETS

## MARINE/OFFSHORE

- 56 REFRIGERATION
- 58 GRAM MARINE
- 60 GRAM MARINE COUNTERS & CABINETS

## ICE MAKERS

- 64 ICE
- 66 **CASE STUDY** LONDON AQUATICS CENTRE
- 68 **CASE STUDY** THE MIXOLOGY GROUP
- 70 **CASE STUDY** THE EDINBURGH ICE CO.
- 72 ABOUT CUBE ICE
- 74 CUBE ICE MAKERS
- 76 ABOUT FLAKE & NUGGET ICE
- 78 FLAKE & NUGGET ICE MAKERS
- 80 ABOUT CRESCENT ICE
- 82 CRESCENT ICE MAKERS
- 84 SPECIAL ICE MAKERS

## DISPENSERS

- 86 ICE AND/OR WATER DISPENSERS

## BEER DISPENSER

- 88 BEER DISPENSER
- 90 ABOUT BEERMATIC
- 92 BEERMATIC DUAL TAP

## SPECIALTIES

- 94 SPECIALTY
- 96 SUSHI CASES, RICE COOKERS & THERMAL FOOD HOLDERS

# LEADING NATURALLY

With the establishment of offices, service hubs and production facilities spanning almost all European regions, Hoshizaki made an important step towards perfectly serving the European food service industry with suitable products closer to European customers and closer to European requirements.

Placing reliability, durability and energy efficiency at the centre of our design process, generations of Hoshizaki engineers have helped us build an international reputation for high quality, well-designed products.

And by merging with refrigeration specialist Gram Commercial, we have brought together the brilliance of Japanese engineering and the intelligence of Danish design. Our collaboration has created the world's most connected, innovative and responsible manufacturer of cold solutions. Together, we continue to explore the realms of possibility.

Global headquarters:  
Aichi, JAPAN  
European headquarters:  
Amsterdam,  
NETHERLANDS



Global sales

1.8 B £



Group of  
52 companies  
worldwide



Factories  
worldwide



## HISTORICAL TIMELINE - DOMESTIC OPERATION

1947

Founded  
in Japan



1957

Development  
of the first juice  
vending machine



1970

Development  
of the beer  
dispenser



1972

Development of  
the commercial  
refrigerator



1977

Development of  
the snow cone  
vending machine



1965

Development of  
the first automatic  
ice maker



1971

Development of  
the hamburger  
vending machine



1973

Development of  
the dish washer



# HISTORY

THE HOSHIZAKI CORPORATION COMPANY WAS FOUNDED BY MR. SHIGETOSHI SAKAMOTO WHO DEMONSTRATED REMARKABLE FORESIGHT WHEN HE STARTED OUR COMPANY IN NAGOYA, JAPAN IN 1947.

Mr. Shigetoshi Sakamoto



From an early stage Mr. Sakamoto recognised the need to invest in research and developing technologies. In 1959, his son Seishi joined the company. Together the pair worked with engineers who shared their vision and the breakthrough came with their invention of the first automatic ice machine in Japan in 1965.



## BRINGING TOGETHER JAPANESE AND DANISH ENGINEERING EXPERTISE

What unites both Hoshizaki and Gram is the tireless drive to push back the boundaries of engineering - always keeping one eye on the convenience for the ones operating the devices and the other eye on the uncompromised quality of fresh produce.

## HISTORICAL TIMELINE - OVERSEAS EXPANSION

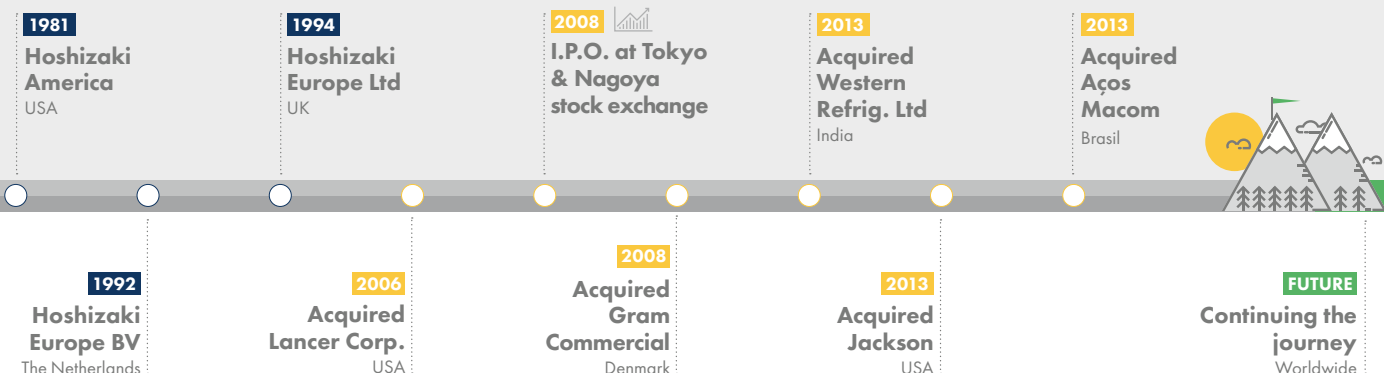

**GREEN. SAFE.  
SMART.**

## GREEN FOOD SERVICE EQUIPMENT FOR A MORE SUSTAINABLE HOSPITALITY INDUSTRY

Always being first movers on the ground, we quickly understood the impact of sustainable refrigeration and icemakers on our nature, our resources and our budgets.

By already adding sustainability to our core values decades ago, we are now one of the few premium manufacturers with full ranges of energy efficient refrigeration equipment and ice makers.

With the ongoing depletion of natural resources, resulting in increased energy and water costs, and emerging energy saving regulations, the food industry of today is confronted with profoundly different challenges than 50, 30 or even just 20 years ago.

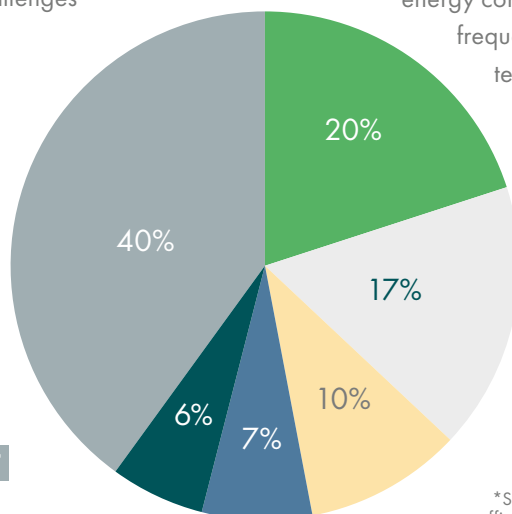

The largest part of the kitchen's electricity consumption is used for cooking, refrigerated storage and dishwashers. In addition, lighting and ventilation draw significant amounts of energy.

Fresh produce requires refrigeration that is usually high in energy consumption, due to uninterrupted running times, frequent door openings and often higher ambient temperatures. On average, refrigeration applications draw approximately 20% of the overall energy consumption in a commercial kitchen.

Considering these stats and being aware that we have a global reach, we are convinced that our efforts towards a cleaner future can and will have a positive impact, when it comes to overall responsible consumption of energy in commercial kitchens worldwide.

\*Source: ProKlima – Der energy-Fonds. Publication: Your Energy – Apply it efficiently (Ihre Energie - Effizient eingesetzt). Information for the Gastronomie



## THE BIGGER PICTURE

WE HAVE MADE THE CHOICE TO EMBED OUR **ENERGY EFFICIENT PRODUCTS** IN A HOLISTIC APPROACH TOWARDS CREATING A BETTER AND GREENER FUTURE.



### R&D AND MANUFACTURING

Research & Development is raising the bar to set new standards in energy and water efficiency. Field research indicates substantial energy saving rates of more than 50% on future Gram counter series. Positive contributions also come from strategic purchasing. Around two thirds of factory supplies to our Danish plant are coming from ISO 14001 certified sub suppliers.



### TRANSPORTATION

Hoshizaki Europe is in the process of building a new distribution network across Europe. With optimisation of logistics to increase direct and coordinated shipments, we will reduce on emissions. Secondly, we will work with forwarders who can provide low emission or electric vehicles.



### UTILIZATION - ENERGY & WATER CONSUMPTION

Between 2017 and 2019 we further improved the energy efficiency of all Gram labelled products by 16%. This result has to be seen in the light of already high energy efficiency performance levels at the outset. Similar to Gram refrigeration, Hoshizaki hydrocarbon ice makers show significantly lower energy and water consumption stats and up to 40% saving potential compared to their competitor equivalents.<sup>1</sup>



### DISPOSAL & RECYCLING

Most components of our machines (95%) are made of recyclable materials. Thus, the disposal process feeds back into a new production cycle. Through dedicated efforts focusing on structural reduction of waste we achieved a substantial decrease of 25% in disposal per unit produced between 2017 and 2019.<sup>2</sup> (Manufacturing site in Vojens, Denmark)

<sup>1</sup> Market research 2018 - manufacturers' websites  
<sup>2</sup> Internal ISO 14001 Review Report

# THINK GLOBAL, REACH LOCAL

## WE ARE WHERE YOU NEED US TO BE

Our local teams and their deep understanding of the highly demanding requirements on the ground have always been key to staying ahead of country-specific regulative requirements, certifications and preferences - always ready to supply each market and each segment of the food service industry with a suitable and sustainable premium product.



## PROPER CARE FOR A BOOSTED DURABILITY AND PERFORMANCE - AND IT IS SO SIMPLE!

Hoshizaki ice makers and refrigeration appliances are considered to be one of the most durable, reliable and energy efficient devices available for the foodservice industry, always keeping the best possible commercial refrigeration equipment, in the industry it is considered as a true investment in improving

quality, hygiene, staff safety and your energy consumption. We encourage our customers to make use of the assistance we provide when it comes to correct installation, maintenance and repair to expand the life expectancy of your device.

**RESPONSIVE AND  
REGIONAL SUPPORT  
INFRASTRUCTURE**



**MULTI-LINGUAL  
SUPPORT AND  
TECHNICAL SERVICE  
TEAMS**



**TECHNICAL TRAININGS  
FOR REPAIR,  
INSTALLATION AND  
MAINTENANCE**



**DEEP UNDERSTANDING  
OF LOCAL  
REQUIREMENTS,  
GUIDELINES AND LAWS**



## ALL-ROUND SUPPORT

WITH EVERY REQUEST, CONSULTATION OR PURCHASE, HOSHIZAKI INTENDS TO BUILD A LONG-TERM PARTNERSHIP. THAT INCLUDES A SERIES OF STEPS TO PROVIDE ALL-ROUND SUPPORT FOR ALL TYPES OF CUSTOMERS FROM A TO Z, NO MATTER IF YOU ARE A DIRECT OR INDIRECT CUSTOMER OF HOSHIZAKI.



### I JUST PURCHASED A PRODUCT. WHO DO I TALK TO NOW?

From day 1, every customer is assigned to a dedicated contact person, either with us or with one of our partners. We believe in direct communication, as well as quick and unbureaucratic contact with all our users and partners.



### HOW CAN I EXTEND MY MACHINE'S LIFE EXPECTANCY

Following your purchase, we support you in maintaining and cleaning your machine properly. It is about sharing the knowledge that helps you to maintain and clean your machine at any given time. The better you care for your machine, the longer it lasts.



### MY MACHINE HAS REACHED ITS LIMITS, WHAT SHALL I DO NOW?

Even the most durable machine comes to its limits one day. When this day comes, you don't have to bother with the disposal, recycling & replacement process. Hoshizaki will take care of everything, once your machine is ready to be disposed.

### COMPREHENSIVE AND UP-TO-DATE TECHNICAL SUPPORT MATERIAL **FOR FREE**



### WORLDWIDE NETWORK OF SUPPORT STATIONS, SERVICE PARTNERS AND REFRIGERATION TECHNICIANS



### BUSINESS **FRIENDLY** WARRANTY TERMS AND CLAIM PROCESSING



## REFRIGERATION

I BELIEVE THAT GREAT CHEFS HAVE A RESPONSIBILITY TO DO MORE THAN SERVE GOOD FOOD. CHEFS SHOULD **SERVE THE WORLD** AND USE THEIR PLATFORMS TO CREATE AWARENESS ABOUT SUSTAINABILITY AND SOCIAL RESPONSIBILITY.

*Rasmus Munk*

Co-owner & Head Chef  
Restaurant Alchemist, Copenhagen

## PREMIUM REFRIGERATION FOR INDIVIDUAL NEEDS

As a supplier to the foodservice industry for many decades we have developed long-lasting relationships. It is the long-term development of our clients that matters. And the new generations of hard-working and ambitious chefs.

Foodsafe, energy efficient and sustainable refrigeration that is easy to work with is what our customers ask for. This is what drives us.

*“Your success is our motivation”*

A correct and uniform temperature throughout your refrigerator is essential. This is a prerequisite for handling food items in line with the HACCP guidelines.

For this, an efficient air distribution system of your refrigerator is essential. Further it also reduces food waste and extends shelf life.



# SAFE, FUNCTIONAL AND HIGHLY EFFICIENT



Category: vertical chilled storage cabinets



## QUICK GUIDE

- ✓ For commercial kitchens/back of house professional kitchens
- ✓ Kitchens and Front of House within Horeca business
- ✓ Suitable for operations in ambient temperatures of up to +40°C
- ✓ Heavy-duty cabinets: climate class 5
- ✓ High performance: stable temperatures despite frequent door openings
- ✓ Meets Gastronorm and shelf size standards

## LEGS, CASTORS OR PLINTH MOUNTING



**L1:** 100 - 130 mm - **L2** (standard): 135 - 200 mm

**C1:** castors 110 mm - **C2:** castors 125 mm

Prepared for plinth mounting at no extra charge.

## TEMPERATURE RANGES

K	M	F
+2/+12°C	-5/+12°C	-25/-5°C

Refrigerator

Fresh meat cabinet

Freezer



# GRAM SUPERIOR & ECO

## KEY FEATURES

### MAXIMUM HYGIENE AND ERGONOMIC STANDARDS

1. Controls concealed behind the top panel, protected against splashing water
2. Low noise and heat emission: low noise level peaking at approx. 45 dB(A)
3. Full length aluminium profiles impart additional strength and durability
4. Wall rails that fit into dishwashers
5. Removable door gasket for easy cleaning
6. Self-closing door with full-height handle providing easy access for cleaning
7. Pan-shaped inside base to catch fluids
8. Patented pedal door opener. Same opener can be placed left or right side

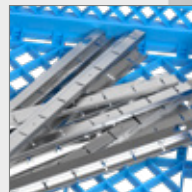

Top view of the profile

Inside door handle:  
2 mm aluminium profile

## USAGE AREAS



Catering Healthcare\* Education Hospitality Leisure Marine Bakery

\*Food storage only, not for bio-medical purposes

### FOOD SAFE

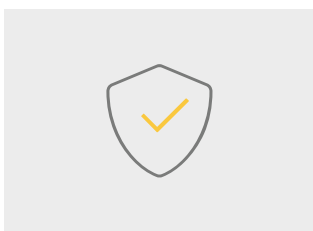

The efficient air circulation system helps to maintain perfect storage temperatures. Designed to recover the inside temperature rapidly after each door opening. Temperatures for optimal food safety are maintained for climate class 5.

### LOW-RUNNING COSTS

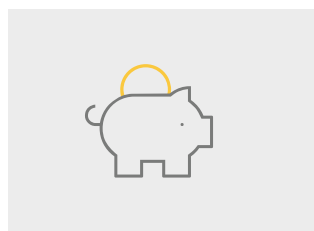

Life time costs of equipment is key to any professional kitchen. The GRAM SUPERIOR PLUS 72 refrigerator has the lowest running costs in its class throughout Europe (topten.eu).

### LOW NOISE

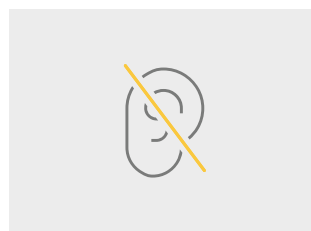

The SUPERIOR range contributes to a healthier work environment with low noise levels at approx. 45 dB(A), when the compressor is running.

### MAXIMUM HYGIENE STANDARDS

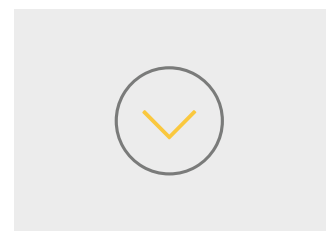

Thanks to the rounded corners and smooth surfaces, frequent cleaning routines become a quick and simple task. Specific features are highlighted above.

## PRODUCT LINE-UP

# FOR YOUR HIGHEST STANDARDS



## ABOUT THE SUPERIOR

GRAM SUPERIOR is a series of high performance cabinets, meeting the sophisticated expectations of our customers, who operate in both casual and fine dining kitchens. Stable and uniform temperatures throughout the cabinet is provided, whilst keeping energy consumption on a revolutionary low in the heat of a commercial kitchen.

SUPERIOR cabinets are characterised by a transparent top panel of impact resistant material.

SUPERIOR K 72 G - winner of 6 sustainability and product excellence awards, including ProCold 'Most Energy Efficient Product in Europe' Award and the Green Good Design award.

## MATERIALS & COMBINATIONS

### EXTERIOR

Stainless steel **C**

Vario silver **R**

### INTERIOR

Stainless steel **C**

Stainless steel **C\***

Aluminium **A**



\*Combination is available for refrigerators with temperature range -5/+12°C





**SUPERIOR PLUS 72**

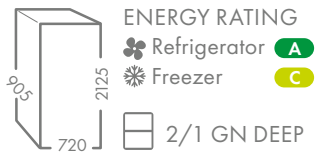

**SUPERIOR TWIN 84**

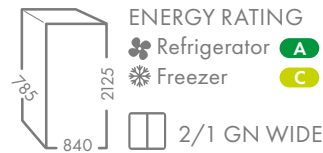

**SUPERIOR EURO 62**

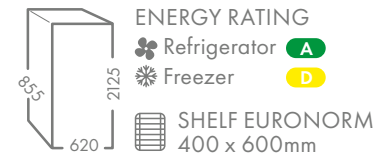

**LET'S COMPARE!  
 UPGRADE NOW – AND START  
 CUT RUNNING COSTS!**

Save up to **79%**

	EXAMPLE	SUPERIOR PLUS K 72 G
⚡ Energy consumption	1348 kWh/year	285 kWh/year
□ Ecodesign Energy rating	G	A
<i>Total costs after 8 years*</i>	<b>£ 1,553.-</b>	<b>£ 328.-</b>

With this A-rated model you save 79% on energy costs compared with a G-rated model.

\*£ 0.144/kWh

# PRODUCT LINE-UP

## MEETING THE NEEDS OF DIVERSE KITCHENS



### ABOUT THE ECO RANGE

The ECO series gained enormous popularity among our customers across all segments of the hospitality and the food service industry. One of the reasons is the wide span of models for different usage areas and purposes. The series can accommodate the most diverse of needs, especially when it comes to capacity and functionalities. At the same time, it does not compromise on energy efficiency and low running costs.

Depending on your specific needs, you can choose your individual setup:

- Single, double or half doors
- Insulated door or glass door
- One or two temperature ranges in one cabinet
- Top or bottom mounted compressor
- Optionally equipped for bakeries or marine

### EXTENDED OPTIONS

-  ECO PLUS 70, half door cabinets.  
Convenient for i.e. fastfood restaurants.
-  ECO TWIN 82, combi-cabinets.  
Combining 2 temperature ranges in one cabinet.
-  GLASS DOOR CABINETS, across all series  
Freezers with glass door in the MIDI series.



### MATERIALS & COMBINATIONS

#### EXTERIOR INSULATED & GLASS DOOR

- |                          |                       |   |
|--------------------------|-----------------------|---|
| Stainless steel <b>C</b> | Vario silver <b>R</b> | White finish <b>L</b> (Insulated door: only for MIDI)<br>(Glass door: only for TWIN / MIDI) |
|--------------------------|-----------------------|---|

#### INTERIOR INSULATED DOOR

- |                          |   |                    |
|--------------------------|---|--------------------|
| Stainless steel <b>C</b> | Stainless steel <b>C</b> * (not for MIDI) | Aluminium <b>A</b> |
|                          | Aluminium <b>A</b>                        |                    |

#### INTERIOR GLASS DOOR

- |                          |  |  |
|--------------------------|--|--|
| Stainless steel <b>C</b> | Aluminium <b>A</b> (not for glass door-MIDI) | Aluminium <b>A</b> (not for glass door-MIDI)     |
|                          |  | White finish <b>L</b> (only for glass door-MIDI) |

\*Combination is available for refrigerators with temperature range -5/+12°C

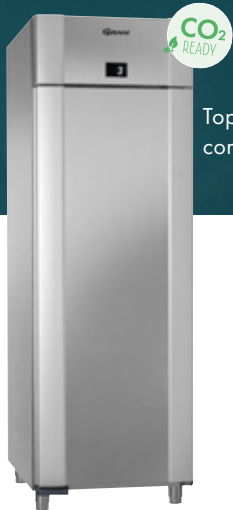

Top-mount  
compressor

### ECO PLUS 70

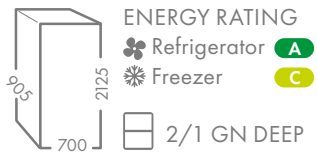

Top-mount  
compressor

### ECO PLUS 140

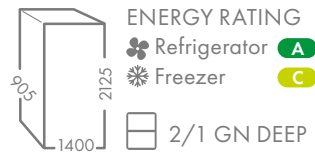

Top-mount  
compressor

### ECO TWIN 82

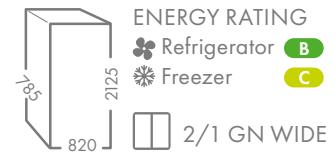

Top-mount  
compressor

### ECO EURO 60

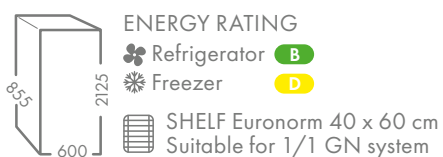

Bottom-mount  
compressor

ECO MIDI M 60  
available as fish  
cabinet equipped  
with fish trays

### ECO MIDI 60

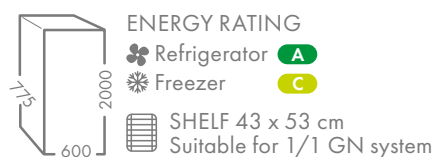

Bottom-mount  
compressor

### ECO MIDI 82

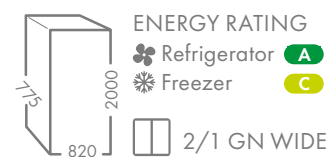

# THE RIGHT FRIDGE FOR THE RIGHT JOB

## ACKNOWLEDGED VIRTUES AND EXTENDED HACCP FUNCTIONS

Food safety is paramount to our customers. GRAM STANDARD PLUS acknowledges this and offers two different stainless steel options to match your requirements. Another dimension of this range is the extended HACCP functionalities that ease your own control procedures. Find the perfect fridge for your individual requirements. The series comprises single and double door cabinets with three temperature ranges each.

## HYGIENIC AND ERGONOMIC FEATURES

1. | Easy monitoring and easy own-control\*
2. | Low noise levels from 44.4 to 54.3 dB(A). Short compressor running times ensures low heat emission
3. | Temperature stability with air circulation system
4. | Removable door gasket for easy cleaning
5. | Self-closing door with integrated, full-height Easy grip and easy access for convenient cleaning
6. | Choice of 2 brushed stainless steel finishes: SS and FF models (double door cabinets are only available as FF models)
7. | SS models with 3 stainless shelves. FF with 3 grey coated shelves
8. | Features for hygiene, such as pan-shaped inside base to catch fluids
9. | Pedal door opener for hands free operation (optional extra)



\* Extended HACCP functionalities for easy monitoring and own control. HACCP data can be easily accessed from the controller and downloaded via a RS485 interface (optional extra) for review on your PC.



Interior **SS** or **FF**  
Exterior **SS** or **FF**



Interior **FF**  
Exterior **FF**

## USAGE AREAS



Catering Healthcare\* Education



Hospitality Leisure Bakery

\*Food storage only, not for bio-medical purposes

### STANDARD PLUS 69 SS/FF

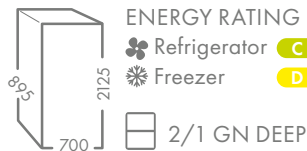

### STANDARD PLUS 139 FF

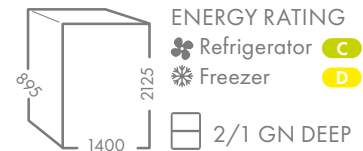

## QUICK GUIDE

- ✓ Ideal for commercial kitchens (Front of House/ Back of House)
- ✓ Suitable for use in ambient temperatures of up to +40°C (tropical)
- ✓ Heavy duty cabinets: Climate class 5
- ✓ High performance, ensuring temperature stability despite frequent door openings
- ✓ Meets 2/1 deep Gastronorm standard

## TEMPERATURE RANGES

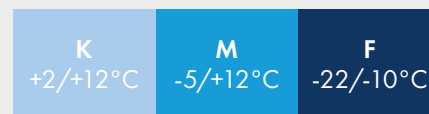

Refrigerator Fresh meat cabinet Freezer

## MATERIALS & COMBINATIONS

### EXTERIOR

Stainless steel **SS**  
 AISI 304  
 (not available for STANDARD PLUS 139)

Stainless steel **FF**  
 AISI 430\*

### INTERIOR

Stainless steel **SS**  
 AISI 304  
 (not available for STANDARD PLUS 139)

Stainless steel **FF**  
 AISI 430\*

\*Stainless steel is nickel-free

# PROFESSIONAL REFRIGERATION - THE COMPACT WAY

## GET THE MOST OUT OF YOUR KITCHEN SPACE

The GRAM COMPACT series offers a rare combination: they are food safe cabinets with a compact size and with excellent energy ratings for its class. With a footprint of only 595 x 642mm (glass door cabinets 674mm) these small space storage cabinets are easy to fit in especially when space is of a premium. This makes the GRAM COMPACT series such a popular choice of small-kitchen-operators who, in most cases, do not require heavy-duty Gastronorm refrigeration equipment.

- ✓ Ideal for commercial kitchens concerned with food preparation (rather than food production)
- ✓ These small footprint cabinets are a perfect pick for self-service areas and satellite kitchens
- ✓ Suitable for all light-duty kitchens where complete stainless steel is not required
- ✓ Suitable for use in ambient temperatures of up to +30°C. Climate class 4: normal-duty cabinets. (FG cabinets are in climate class 3)



COMPACT 420

### LEGS, CASTORS OR PLINTH MOUNTING



**L1** (standard): 100 - 130 mm - **L2**: 135 - 200 mm  
**C2**: castors 125 mm

### TEMPERATURE RANGES

K	M	F	F
+2/+12°C	-5/+12°C	-22/-5°C	-25/-5°C
Refrigerator	Fresh meat cabinet COMPACT 610	Freezer COMPACT 220/420	Freezer COMPACT 610



# GRAM COMPACT

## KEY FEATURES

### FOOD SAFE, HYGIENIC, ERGONOMIC AND GOOD WORK ENVIRONMENT

1. | Low noise ratings
2. | Air circulation system ensures temperature stability
3. | Removable door gasket for easy cleaning
4. | Full-height integrated handle. Easy grip and easy access for cleaning
5. | Nickel-free stainless steel (stainless models) – no risk of allergic reactions
6. | Anti-spillage and waste control: shelves are equipped with tilt prevention
7. | Automatic defrost
8. | PS inner lining in one piece: no gaps, no accumulation of contamination
9. | Pedal door opener for handsfree operation (optional accessory, not included for COMPACT 220)



## USAGE AREAS



Catering Healthcare\* Education Hospitality Leisure Marine

\*Food storage only, not for bio-medical purposes

 CABINETS WITH GLASS DOOR  
The door is equipped with LED lighting to provide perfectly illuminated storage goods.



### FOOD SAFE



Thanks to the Gram air distribution system temperatures are correct and uniform throughout the entire cold room, maintaining food safe temperatures at all times - not just for bottle cooling.

### LOW-RUNNING COSTS

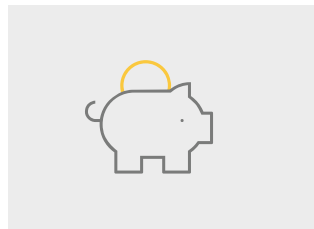

With energy labels ranking from A to C (HC models), the COMPACT 220 and 420 offer the most energy efficient, compact models in the marketplace.

### LOW NOISE

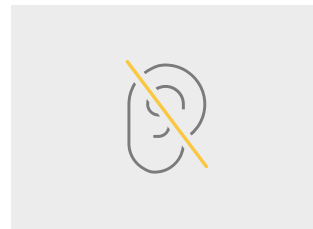

Contributes to a healthier work environment with low noise levels from 30.1 to 38.5 dB(A), when compressor is running. Low heat emission due to short compressor running times.

### HIGH STANDARD IN HYGIENE

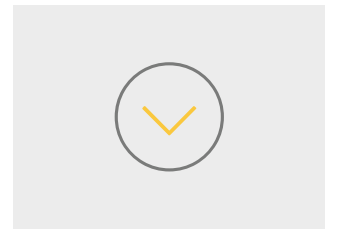

Designed for easy cleaning with smooth surfaces throughout. Specific features are highlighted above.

# PRODUCT LINE-UP

## VERSATILE, FLEXIBLE AND ROBUST

### HIGHLY VERSATILE AND SPACE SAVING

With their small footprint these storage cabinets are easy to fit in especially when space is of a premium. Additionally COMPACT 220 fits under worktops and as a stand-alone device it provides extra work space with its 'table top'.

### THE POWER OF TEMPERATURE CONTROL

A smart temperature concept is paramount to a sustainable, food-safe and efficient kitchen environment, but it also helps to preserve the taste, texture and nutritional content of fresh ingredients. The COMPACT 220



and the 420 series come with a new touch panel for intuitive operation and temperature control. It provides improved setup possibilities with simplified functions for daily use. For example, the controller features direct access to configure HACCP alarms and an integrated switch button for the illumination of the glass door cabinets. The displayed temperatures are easily readable, even from a distance. With simple key combinations for troubleshooting, the new controller significantly simplifies serviceability.

All units are equipped with an efficient refrigeration system that maintains stable and uniform temperatures throughout the cabinet. The refrigerator and freezer models with insulated doors are classified as climate class 4, withstanding ambient temperatures of up to 30°C. The COMPACT 220 glass door freezer units are classified climate class 3.

### MATERIALS & COMBINATIONS

#### EXTERIOR

Stainless steel



White Finish



#### INTERIOR

Polystyrene (PS) white



(COMPACT 220, 420)

Polystyrene (PS) white



(COMPACT 220, 420)

Polystyrene (PS) grey



(COMPACT 610)

Polystyrene (PS) grey



(COMPACT 610)

Stainless steel is nickel-free





**COMPACT K & F 220**

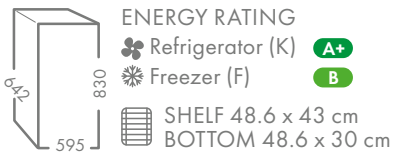

**COMPACT K & F 420**

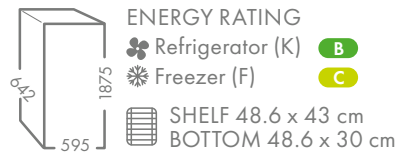

**COMPACT K & F 610**

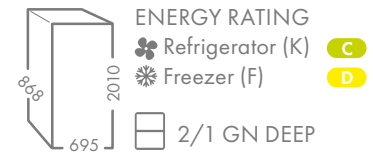

**COMPACT KG & KF 220**

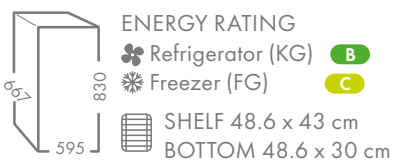

**COMPACT KG 420**

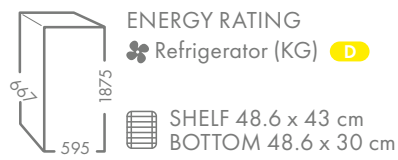

**COMPACT KG 610**

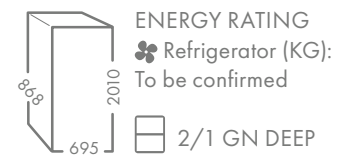

## KEEP UP THE COLD CHAIN

### LIGHTEN YOUR WORKLOAD AND KEEP THE COLD CHAIN UNBROKEN

Roll-in cabinets are designed for temporary refrigerated storage within a production line, positioned for example between blast chillers and refrigerated coldrooms. By utilising roll-in cabinets, the refrigeration process is unbroken, minimizing any manual workload for handling and re-loading. Typically, roll-in units are used for commercial kitchens with focus on production, preparation and cook-chill operations.

#### EFFECTIVE TEMPERATURE CONTROL: HYGIENIC, SAFE AND STURDY

1. Safety first – controller with built-in alarm, door surveillance and emergency programs
2. Two halogen lamps provide illumination when the door is opened (models with insulated door)
3. Temperature stability with air circulation system
4. Removable door gasket for easy cleaning
5. Nickel-free stainless steel: no risk of allergic reactions.
6. Reversible door with cold-retaining strip. Sturdy handle with a 'positive' closing system
7.  Cabinets with glass doors are equipped with an integral light
8. Impact cushions protect the stainless surfaces from bumps and knocks
9. A compact stainless steel floor with drive-in ramp is optional for K & M models. Roll-in freezer comes with heated floor as standard



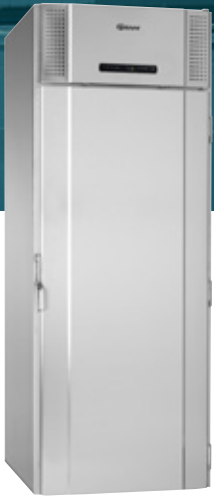

### K & M 1500 REFRIGERATOR

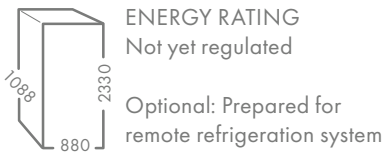

ENERGY RATING  
Not yet regulated

Optional: Prepared for remote refrigeration system

Dimensions internal: W 720 x D 895 x H 1900



### KG 1500 REFRIGERATOR WITH GLASS DOOR

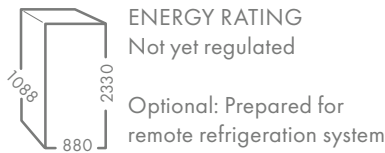

ENERGY RATING  
Not yet regulated

Optional: Prepared for remote refrigeration system

Dimensions internal: W 720 x D 895 x H 1900



### F 1500 FREEZER

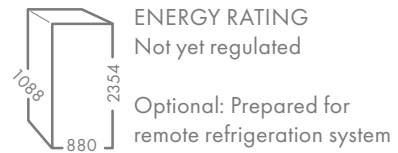

ENERGY RATING  
Not yet regulated

Optional: Prepared for remote refrigeration system

Dimensions internal: W 720 x D 895 x H 1900

### USAGE AREAS



Catering Hospitality Bakery

- ✓ With an internal clear height of 1900 mm the cabinets are ideal for most trolleys currently used in commercial kitchens
- ✓ Heavy-duty cabinets: Climate class 5. Suitable for use in ambient temperatures of up to +40°C (tropical)
- ✓ High performance: Temperature stability despite frequent door openings

### TEMPERATURE RANGES

<b>K</b> +2/+12°C	<b>M</b> -5/+12°C	<b>F</b> -25/-5°C
Refrigerator	Fresh meat cabinet	Freezer

## MATERIALS & COMBINATIONS

### EXTERIOR

Stainless steel

### INTERIOR

Stainless steel

Stainless steel is nickel-free



*"We can't afford for a fridge to break down, even short term."*



## WE NEED EQUIPMENT THAT CAN DELIVER

The kitchen has four undercounter units; one for meat and fish, one for garnish, one for larder and pastry, and one for breakfast service.

The undercounter units found in the kitchen at Charlotte's W5 feature refrigerated drawer storage space in a range of sizes. Each drawer is specifically designed for its Gastronorm compatibility and the units are fitted with castors for simple positioning and to simplify cleaning routines.

"I find the size and format of the GRAM GASTRO range to be extremely versatile. We can fit up to nine of the GN 1/4 containers in each drawer – something that is particularly useful in our garnish fridge, which we use for a variety of different ingredient." Lee states.





## CHARLOTTE'S W5

### LONDON, ENGLAND

#### Award-winning

Bar and restaurant in West London

#### Establishment address

Longfield Avenue, Ealing, West London

#### Head Chef

Lee Cadden

#### Launch year

2016, part of renowned 'Charlotte's Group'

#### Gram equipment

Four GRAM GASTRO undercounter units

Charlotte's W5 is the newest addition to the strong portfolio of three restaurants in West London. They all are part of the renowned 'Charlotte's Group', founded in 1984 by CEO Alex Wrethman. Stunningly set in a converted warehouse, right in the trendy borough of Ealing, the bistro attracts a mix of loyal local guests and visitors from far away, obviously triggered by the overwhelmingly positive echo in the past years.



"In order to maintain freshness and produce the menu our guests expect, we need equipment that can deliver, and although it might not be an exciting piece of kit, having reliable refrigeration is vital."



Charlotte's W5 is a British Brasserie with a menu built around the quality, provenance and sustainability of ingredients. The sourcing of ingredients is vital to creating the ever-changing dishes on the menu.

# THE CHEF'S PRIME WORKSTATION



GASTRO 07 SALADETTE

## A HIGHLY MODULAR WORKHORSE

A refrigerated counter is the chef's prime workstation. Therefore it often occupies a central position in the kitchen. Besides its storage function the counter has a central role from preparation through to arranging and serving the food.

The GRAM GASTRO 07 and 08 ranges offer highly modular refrigerated counters in a variety of configurations. They are popular with our customers because they can deliver, day in day out, with excess refrigeration capacity.

### TEMPERATURE RANGES

<b>K</b> +2/+12°C	<b>K</b> 0/+10°C	<b>M</b> -5/+12°C	<b>F</b> -25/-5°C
Refrigerator	Snack counter	Fresh meat	Freezer

## QUICK GUIDE

- ✓ Application areas: from hot commercial kitchens to the elementary lunch line. For Back of House or as workstation at Front of House, cold buffets or as a serving station, use in production lines from raw materials to finished items and food preparation and storage at the point of preparation
- ✓ Prep-counters for catering and food processing, restaurants, bars or cafés. Snack counters are refrigerated low counters combined with modular cooking appliances. Ideal also as pass-through for double working stations
- ✓ Heavy-duty cabinets: climate class 5 refrigerators for hot professional kitchens. Freezers: climate class 4
- ✓ High performance counters: stable temperatures despite frequent door openings
- ✓ Compliant with Gastronorm standards

## KEY FEATURES

### GOOD HYGIENE, ERGONOMICS AND WORK ENVIRONMENT

1. | 'Drip nose' edges on worktops prevent ingress of water
2. | Worktops with splash backs to protect your counter from spillage
3. | Air circulation system for temperature stability
4. | Removable drawer and door gaskets for easy cleaning
5. | Pan-shaped inside base with rounded corners catches fluids
6. | Ergonomic and height-adjustable working station with electrical elevation\*
7. | Anti-tilt shelves and drawers with pull-out stop
8. | Extra-long telescopic rails on drawers – GN trays can be lifted in and out without tilting
9. | Maximum hygiene: rounded corners, minimal screws and fixings for easy wiping
10. | Allergy-proof: counters are made from nickel-free stainless steel



\*ULTIMATE ERGONOMICS  
Entirely flexible working height between 850 – 1050 mm with electric elevation (optional).



### USAGE AREAS



\*Food storage only, not for bio-medical purposes

#### FOOD SAFE



Thanks to the Gram air distribution system, temperatures inside the counters maintain a uniform and correct temperature at all times. This includes rapid temperature recovery after every door opening.

#### MODULARITY AND SCALEABILITY

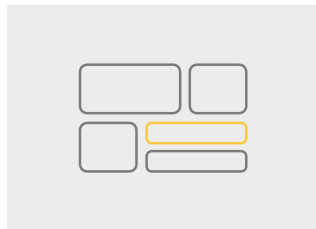

With GRAM GASTRO 07 & 08 you can build your own work place. Choose your combination of work top, doors and drawers, legs or castors or electric elevation, temperature ranges and accessories.

#### EASY MAINTENANCE AND SERVICE



A compact slide-out refrigeration unit for easy maintenance and service access. Removable and easy to clean condenser filters and gaskets.

#### HIGH STANDARD IN HYGIENE

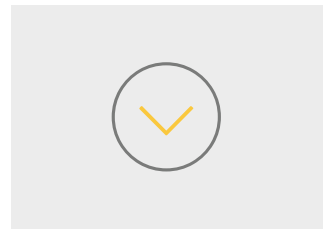

Designed for easy cleaning with smooth surfaces throughout. Specific other features are highlighted above.

## PRODUCT LINE-UP

# 70 CM DEEP. 1/1 GASTRONORM. NUMEROUS APPLICATIONS.

## A WIDE VARIETY OF OPTIONS

### GASTRO 07 ADAPTS TO YOUR WORKING DAY

Start configuring your GASTRO 07 counter:

- Available with three temperature ranges
- Available with two, three or four sections
- Worktop options as shown
- Doors, 2/2 drawers sets or 3/3 drawer sets (no drawers for freezer counters or prep top worktop)
- With or without lock
- Legs, castors, plinth mounted or electric elevation
- Built-in or remote refrigeration system
- Rack with 2 shelves can be fitted onto the worktop

### LEGS, CASTORS OR PLINTH MOUNTING



**L1:** 100 - 130 mm - **L2** (standard): 135 - 200 mm

**L3:** 185 - 250 mm - **C1:** castors 127 mm

**C2:** castors 155 mm

Prepared for plinth mounting at no extra charge.

## MATERIALS & COMBINATIONS

### EXTERIOR

Stainless steel **C**

### INTERIOR

Stainless steel **C**

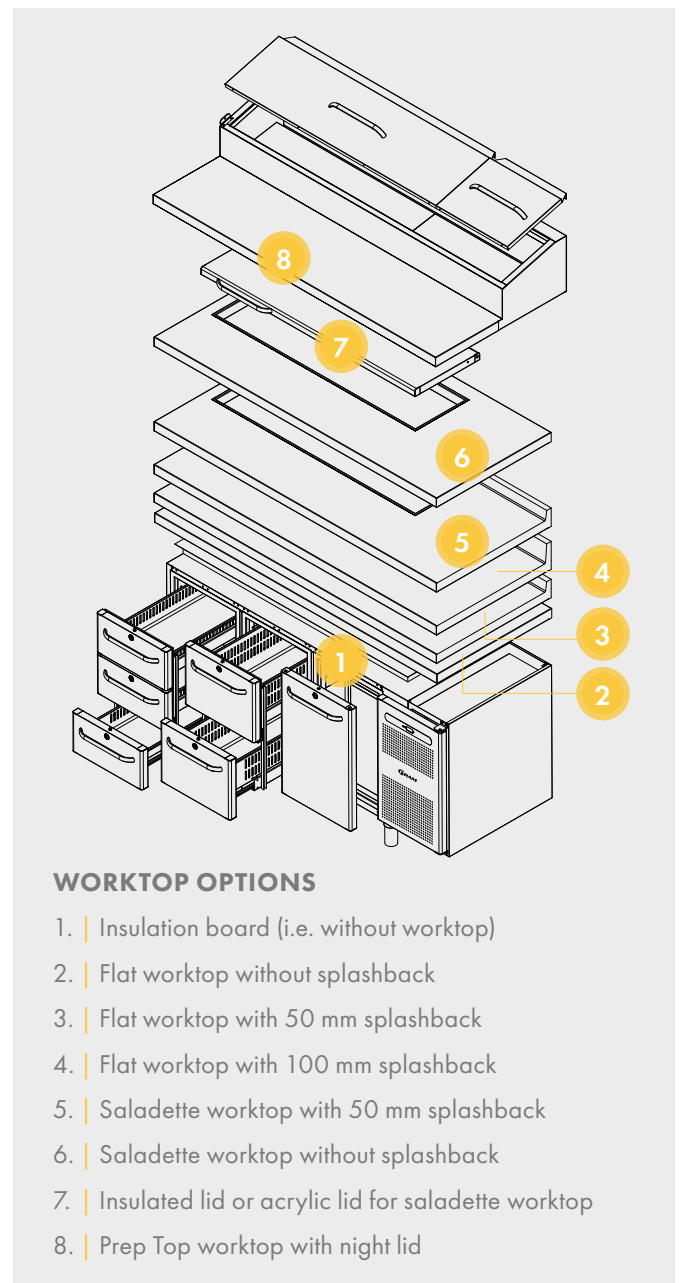

### WORKTOP OPTIONS

1. | Insulation board (i.e. without worktop)
2. | Flat worktop without splashback
3. | Flat worktop with 50 mm splashback
4. | Flat worktop with 100 mm splashback
5. | Saladette worktop with 50 mm splashback
6. | Saladette worktop without splashback
7. | Insulated lid or acrylic lid for saladette worktop
8. | Prep Top worktop with night lid

Stainless steel is nickel-free





## GASTRO 1407

(2 sections)

ENERGY RATING of configuration shown

☼ Refrigerator (K) **D** (M) **E**



## GASTRO 1807

(3 sections)

ENERGY RATING of configuration shown

☼ Refrigerator (K) **D** (M) **E**



## GASTRO 2207

(4 sections)

ENERGY RATING of configuration shown

☼ Refrigerator (K) **D** (M: not with drawers)



Drawer combinations are not available for refrigerated counter model GASTRO M 2207 CS and not for any freezer counter



## GASTRO 07 SALADETTE

(2/3/4 sections, doors only)

ENERGY RATING

(K) Not yet regulated



2 sections: W 1289 - 4 sections: W 2163



## GASTRO 07 PREP TOP

(2/3/4 sections, doors only)

ENERGY RATING

(K) Not yet regulated



2 sections: W 1289 - 4 sections: W 2163



## GASTRO 07 SNACK

(2/3 sections, drawers only)

ENERGY RATING

☼ Refrigerator (K) **D**



2 sections: W 1400

## PRODUCT LINE-UP

# 80 CM DEEP. 2/1 GASTRONORM. PASS-THROUGH OR REACH-IN.

## A SERVICE STATION OR A DOUBLE WORK STATION

### BECAUSE EVERY KITCHEN IS DIFFERENT

Start configuring your GASTRO 08 Counter:

- Reach-in or pass-through double work station
- Available with 3 temperature ranges (pass-through only as refrigeration counters, K-models)
- Available with two or three sections
- Worktop options as shown
- Doors with or without lock
- Legs, castors, plinth mounted or electric elevation
- Built-in or remote refrigeration system
- Gantry with 2 shelves can be fitted onto the worktop

### LEGS, CASTORS OR PLINTH MOUNTING



**L1:** 100 - 130 mm - **L2** (standard): 135 - 200 mm

**L3:** 185 - 250 mm - **C1:** castors 127 mm

**C2:** castors 155 mm

Prepared for plinth mounting at no extra charge.

## MATERIALS & COMBINATIONS

### EXTERIOR

Stainless steel

### INTERIOR

Stainless steel

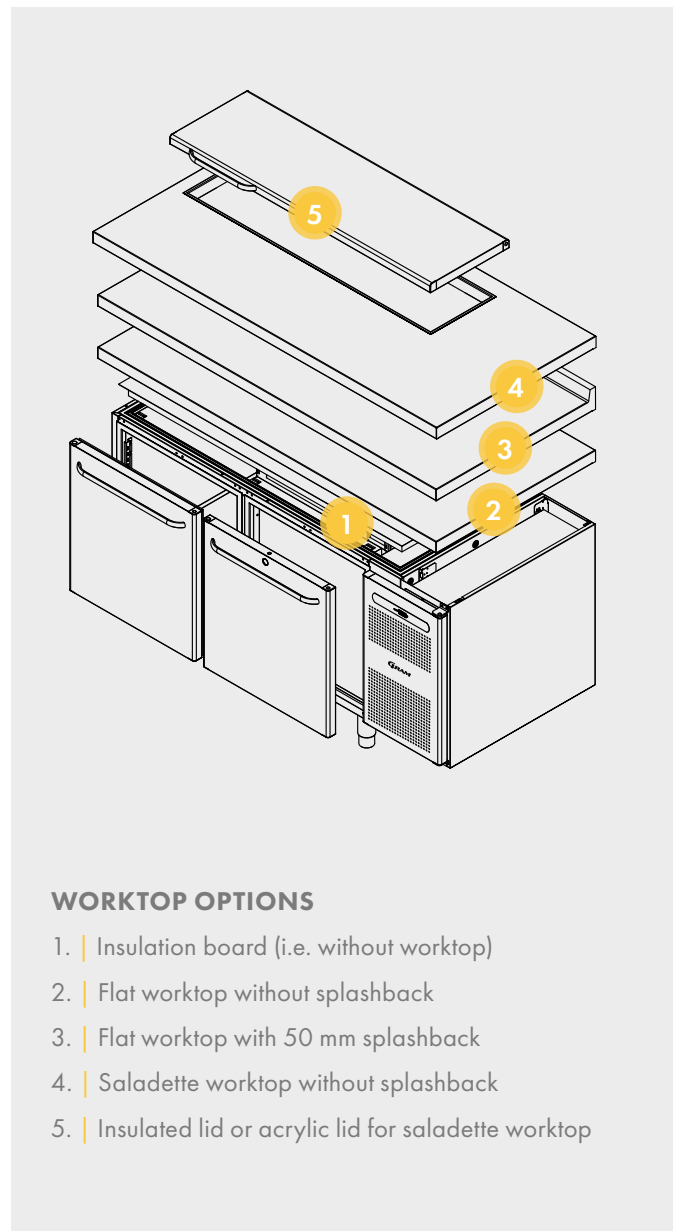

### WORKTOP OPTIONS

1. | Insulation board (i.e. without worktop)
2. | Flat worktop without splashback
3. | Flat worktop with 50 mm splashback
4. | Saladette worktop without splashback
5. | Insulated lid or acrylic lid for saladette worktop

Stainless steel is nickel-free



# GRAM GASTRO 08



**GASTRO 1808**  
(2 sections) REACH-IN

ENERGY RATING

☼ Refrigerator (K) **C** (M) **D** (F) **D**



**GASTRO 2408**  
(3 sections) REACH-IN

ENERGY RATING

☼ Refrigerator (K) **D** (M) **E**



**GASTRO 1808/2408 SALADETTE**  
(2/3 sections) REACH-IN

ENERGY RATING

(K) Not yet regulated



2 sections: W 1700



**GASTRO 1808 D**  
(2 sections) PASS-THROUGH

ENERGY RATING

(K) Not yet regulated



**GASTRO 2408 D**  
(3 sections) PASS-THROUGH

ENERGY RATING

(K) Not yet regulated



**GASTRO 1808/2408 D SALADETTE W/GANTRY**  
(2/3 sections) PASS-THROUGH

ENERGY RATING

(K) Not yet regulated



2 sections: W 1700

# CONTROLLING AND MONITORING CRITICAL FOOD TEMPERATURES



GRAM KPS 90

Multifunctional Gram quick-chillers on page 40



## MASTERING THE ART OF TEMPERATURE CONTROL

Blast chilling and freezing are integral parts of any cook-chill operation in food production. Possibilities to immediately chill or freeze cooked food for safe storage.

The GRAM KPS series has been designed to cover all regulations around the perfectly hygienic transition from cooking to chilling your valuable produce. With capacities ranging from 22 kg to 180 kg for blast chillers and 13 to 180 kg for blast freezers, this series offers suitable options for various kitchen layouts and purposes.

### BLAST CHILL PRODUCTION OF FOOD



### BLAST FREEZE PRODUCTION OF FOOD





# GRAM KPS BLAST CHILLERS/FREEZERS

## REACH-IN, ROLL-IN OR ROLL-THROUGH

Our goal is to always cater to the individual processes and requirements that come with different segments, guest capacities or space limitations. That is why this series offers a number of outstanding options.

 REACH-IN models:  
KPS 21, 42

 ROLL-IN models:  
KPS 60, 90, 120, 180

 ROLL-THROUGH models:  
KPS 120, 180

### MODULARITY FOR INDIVIDUAL NEEDS

The largest blast chillers/freezers KPS 120 and 180 are available as modules to suit individual needs:

#### MODULE 1: NO ROOM

Includes electronic controller and the evaporator unit.

#### MODULE 2: EXTENDED PACKAGE INCL. ROOM

This option includes a Gram room which ensures full compatibility with the evaporator unit.

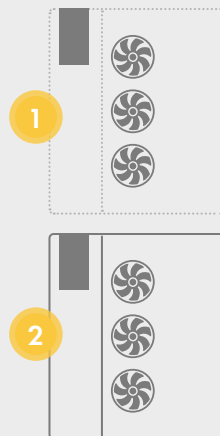

#### MODULE 3: FULL PACKAGE

This option also includes the refrigeration unit and assembly.

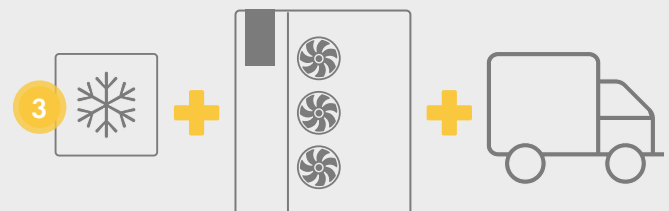

NB: Module 3 is not available for all markets. Please contact our customer service.

### USAGE AREAS



Catering Healthcare\* Education Hospitality Leisure

\*Food storage only, not for bio-medical purposes

✓ This series is often chosen by restaurants, production kitchens or food production facilities which require efficient and effective methods to chill down and freeze already portioned food - always on point, with taste and texture always perfectly protected throughout the entire process.

#### FOOD SAFE



Food items handled in full compliance with the HACCP guidelines. HACCP alarms and an automatic shift to 'storage mode' are useful extras to help you to ensure highest food safety at all times.

#### HIGH FOOD QUALITY



Taste, texture, appearance as well as vitamins and nutrient content are preserved.

Use of IFR function also protects against surface freeze damage.

#### VERSATILITY

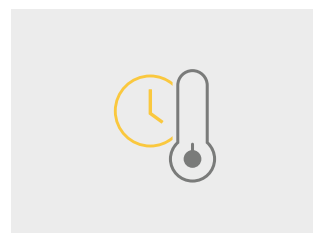

Offers different operational modes: IFR operation, time or temperature controlled chill cycle.

Up to 20 customized cycles can be stored.

#### MODULARITY AND SCALEABILITY

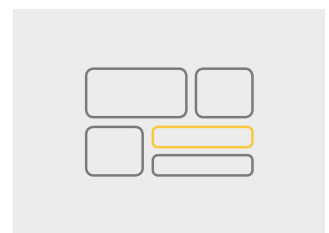

Capacities from 13 to 180 kg of food. Reach-in, roll-in or roll-through models for small or big scale operations. Part delivery or turn key.

# PRODUCT LINE-UP

## INTELLIGENT FOOD RECOGNITION - IFR

### YOUR PRODUCTS DESERVE THE BEST IN PACE, POWER AND PROTECTION

With the IFR control system it has never been easier to control food temperatures and chilling times when running a blast chilling cycle - without any risk of surface freezing damage. Simply press the IFR short cut button and the blast chilling cycle is automatically adapted to the food item's characteristics. This means the food items are brought safely through the high risk temperature range of +65°C and +10°C while maintaining taste and appearance.

#### SAFE AND EASY HANDLING OF YOUR FOOD



Multipoint sensor with 3 measuring points: temperature at the core, beneath the surface and on the surface of the food.



KPS 21 and 42 with encoder wheel for easy and intuitive navigation.



Five short cuts: quick and safe operation with short cuts to most frequently used operations:

1. Defrosting cycle
2. IFR function
3. Blast chilling
4. Blast freezing cycle
5. Pre-cooling cycle.

### MATERIALS

#### EXTERIOR

- |   |                                       |
|---|---------------------------------------|
| Stainless steel <input checked="" type="checkbox"/> | White finish <input type="checkbox"/> |
|   | <small>*KPS 120 and 180</small>       |

#### INTERIOR

- |   |   |
|---|---|
| Stainless steel <input checked="" type="checkbox"/> | Stainless steel <input checked="" type="checkbox"/> |
|---|---|

Stainless steel is nickel-free



#### LEGS

- KPS 21: 80 mm - KPS 42: 150 mm  
KPS 90-SF1: 295 mm - KPS 90-SF2: 225 mm

#### BLAST CHILLING/FREEZING COMBINATIONS

- |   |   |
|---|---|
| <input checked="" type="checkbox"/> CH Blast Chiller with built-in compressor | <input checked="" type="checkbox"/> SH Blast Chiller/Freezer with built-in compressor |
| <input checked="" type="checkbox"/> CF Blast Chiller for remote connection    | <input checked="" type="checkbox"/> SF Blast Chiller/Freezer for remote connection    |

# GRAM KPS BLAST CHILLERS/FREEZERS



CH SH

**KPS 21 REACH-IN**

CAPACITY  
 ❁ Chilling: 22 kg  
 ❁ Freezing: 13 kg  
 Rack: **5** positions for 1/1 GN & 40 x 60 cm bakery plates

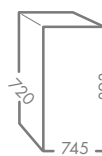

CO<sub>2</sub> READY

CH SH  
CF SF

**KPS 42 REACH-IN**

CAPACITY  
 ❁ Chilling: 45 kg  
 ❁ Freezing: 27 kg  
 Rack: **10** positions for 1/1 GN & 40 x 60 cm bakery plates

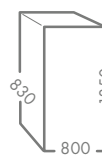

CO<sub>2</sub> READY

CH  
CF

**KPS 60 ROLL-IN**

CAPACITY  
 ❁ Chilling: 60 kg  
 Trolley for Rack: **16** positions for shelves 1/1 GN (optional)

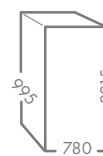

SF

**KPS 90 SF-1/SF-2 ROLL-IN**

CAPACITY  
 ❁ Chilling: 90 kg  
 ❁ Freezing: 50 kg  
 Oven trolley capacity: **20** x 1/1 GN trolleys\*



CO<sub>2</sub> READY

CF SF

**KPS 120 ROLL-IN/ROLL-THROUGH**

CAPACITY  
 ❁ Chilling: 120 kg  
 ❁ Freezing: 120 kg

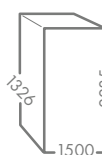

CO<sub>2</sub> READY

CF SF

**KPS 180 ROLL-IN/ROLL-THROUGH**

CAPACITY  
 ❁ Chilling: 180 kg  
 ❁ Freezing: 180 kg

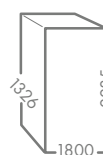

\* Oven trolley compatibility: Rational CPC 201 (SF-1) - Hounö Type 1.16/1.20 (SF-1) - Rational SCC 201 (SF-2), iCombi Pro & Classic 20-1/1 (SF-4)

# PRODUCT LINE-UP

## MULTIFUNCTIONAL CABINETS

### '6-IN-1' CABINETS

Gram Quick Chillers are true multifunctional cabinets. Sophisticated electronic controls offer the choice of six different functions:

1. REFRIGERATION
2. FREEZING
3. QUICK CHILL
4. QUICK FREEZE
5. CONTROLLED THAWING
6. DRY COOLING

**LEGS, CASTORS OR PLINTH MOUNTING**  
L1: 100 - 130 mm - L2 (standard): 135 - 200 mm  
C1: castors 110 mm - C2: castors 125 mm  
Prepared for plinth mounting at no extra charge.

### MATERIALS & COMBINATIONS

#### EXTERIOR

Stainless steel

#### INTERIOR

Stainless steel

Stainless steel is AISI 304

✓ This series is typically selected by operations which need a less powerful device than a classic blast chiller, but seek to benefit from the versatility provided by a quick chiller.

#### TEMPERATURE RANGE

STORAGE -25/+10°C	QUICK CHILL -30/+10°C
----------------------	--------------------------

#### USAGE AREAS



Catering Healthcare\* Education Hospitality Leisure

\*Food storage only, not for bio-medical purposes





# GRAM QUICK CHILLERS/FREEZERS



**KP 60 QUICK CHILLER**



**KP 82 QUICK CHILLER**

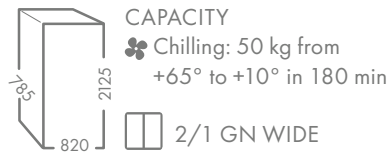

**U/KP 82 COMBI CABINET**



**Smart Double Function:**

This model can be operated as both quick chiller and storage cabinet. Storage with 'universal' temperature range is built into the upper section.



**MULTIFUNCTIONAL**

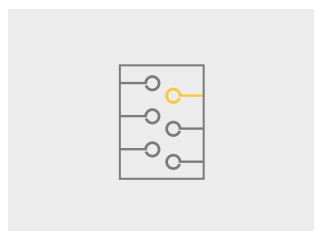

All in One. Multi-purpose cabinet with SIX operation modes. Outside of a chilling or freezing process it can simply be used as a storage refrigerator or freezer.

**FOOD SAFE**

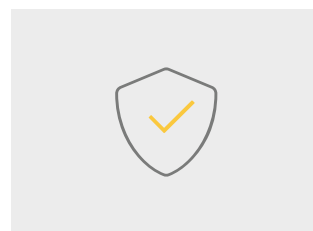

Maintaining safe temperatures with an efficient air circulation system, which also ensures fast temperature recovery each time the door is opened.

**EASY TO OPERATE**

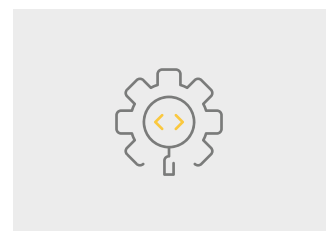

This series provides time or temperature controlled chilling/freezing processes. Preset programs can be operated directly via the display to run either 'Soft Chill' for a gradual chilling or 'Hard Chill' for fast rapid freezing.

## PRODUCT LINE-UP

**RELIABLE. DURABLE.**  
**AFFORDABLE.**

### QUALITY COOLING YOU CAN RELY ON

The Snowflake GII refrigerated and freezer cabinets are brought to you by Japanese and Danish engineering excellence, dedicated to simplifying day-to-day work routines of kitchen staff all around the world. The technology behind the performance of Snowflake GII is the tropicalised cooling system enduring up to +40°C. Additionally, the cooling agent of the new generation of Snowflake is the eco-friendly refrigerant R290, a natural gas (HC) that enhances the performance and cuts down energy consumption significantly. Both interior and exterior are built of sturdy and easy-to-clean stainless steel, which is among the best choices when it comes to materials for hygienic and food safe cooking environments.

### FOOD SAFE, HYGIENIC AND ERGONOMIC

1. | Ergonomic full-height handle
2. | Cabinet height of < 2m for low-ceiling buildings and kitchens
3. | Removable and double insulated magnetic gaskets for easy cleaning and minimal heat dispersion
4. | Reversible door for flexibility
5. | Easy-to-clean interior and shelves with anti-tilting function to prevent from tilting when pulled out
6. | Inside base with rounded corners for easy cleaning

#### LEGS, CASTORS OR PLINTH MOUNTING



L: Legs 130 mm

C: Castors 130 mm

Plinth mounting at site by removing legs or castors.





## USAGE AREAS



Catering Healthcare\* Education



Hospitality Leisure

\*Food storage only, not for bio-medical purposes

### SUR-65DG/SUF-65DG

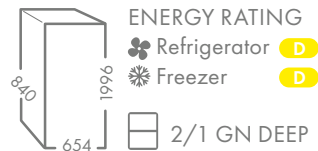

### SUR-135DG/SUF-135DG

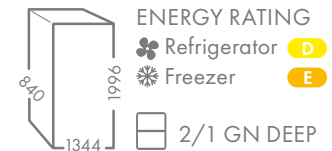

## QUICK GUIDE

- ✓ Ideal for commercial kitchens (Front of House/ Back of House)
- ✓ Suitable for use in ambient temperatures of up to +40°C (tropical)
- ✓ Heavy Duty cabinets: Climate class 5 (SUF-135 DG climate class 4)
- ✓ High performance, ensuring temperature stability despite frequent door openings
- ✓ Meets 2/1 deep Gastronorm standard

## TEMPERATURE RANGES

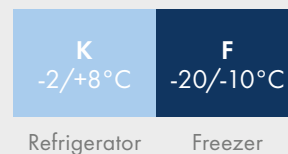

## MATERIALS & COMBINATIONS

### EXTERIOR

Stainless steel **C**

### INTERIOR

Stainless steel **C**

Stainless steel is nickel-free

# PRODUCT LINE-UP

RELIABLE. DURABLE.  
AFFORDABLE.

## QUALITY COOLING TO RELY ON

The Snowflake GII series was developed out of the dedication to serve those who work under pressure, in the heat of a commercial kitchen with limited space – every day.

The series comprises single and double door refrigerators and freezers, refrigerated counters and blastchillers/freezers.

The Snowflake GII range is manufactured utilising the best engineering, design technologies and strict quality assurance from our teams in Denmark and Japan.

## HYGIENIC AND ERGONOMIC FEATURES

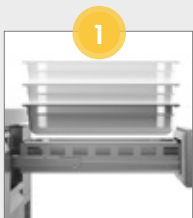

1  
Extra-long drawer telescopic rails.

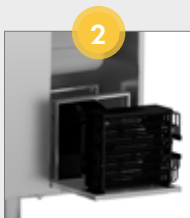

2  
Cleaning-free extractable condenser.

Worktop with splashback for spillage control (optional).



## MATERIALS

### EXTERIOR

Stainless steel **C**

### INTERIOR

Stainless steel **C**

Optional 2 and 3 drawer sections:

▬ W 330 x D 543 x H 201 mm (inside)

▬ W 330 x D 543 x H 101 mm (inside)

## TEMPERATURE RANGE

K  
-2/+8°C

Refrigerator

Stainless steel is nickel-free



# SNOWFLAKE GII

## USAGE AREAS



Catering Healthcare\* Education Hospitality Leisure

\*Food storage only, not for bio-medical purposes

- ✓ Generally popular for commercial kitchens/back of house and for front of house kitchens within hospitality businesses
- ✓ Heavy Duty cabinets: climate class 5. Suitable the ambient temperatures of up to +40°C (tropical)



## SCR 130/180/225 DGRR (2/3/4 sections) REACH-IN

ENERGY RATING

Refrigerator (K) **C**



1/1 GN DEEP

2 sections: W 1314 - 3 sections: W 1780

### HIGH STANDARD IN HYGIENE



Interior and exterior: anti-corrosion stainless steel. Suitable for humid locations. Base with rounded corners and removable gaskets for easy wiping. Worktop with splashback for spillage control (optional).

### EASY MAINTENANCE AND SERVICE



Cleaning-free extractable condenser lowers maintenance costs, eases service and ensures stable performance.

### HIGHLY CONFIGURABLE



Configurable with the option of combining with flat worktop or with 100 mm splashback and multiple door-drawer combinations. (Contact your local sales office for a specified quotation).

### SUSTAINABLE AND EFFICIENT



This series has a low energy consumption, uses natural refrigerants and is future proof.

## PRODUCT LINE-UP

# ESSENTIALS FOR CONVENIENCE AND TASTE

## RELIABLE. DURABLE. AFFORDABLE.

Snowflake blast chillers and freezers were designed with a strong focus on the real essentials: durable materials, sturdy design, perfect performance and instant convenience, when it comes to cleaning and maintenance.

### THE PROTECTIVE MODE : HARD AND SOFT CHILL

Cycles in HARD and SOFT mode are available to regard all types of food. Snowflake blast chillers can be operated in both 'Hard Chill' and 'Soft Chill' - mode and therefore suitable for a diversity of produce and foods.

**LEGS**  
SBU 15 & SBU 20: 75-108 mm  
SBU 40: 105-155 mm

## MATERIALS & COMBINATIONS

### EXTERIOR

Stainless steel **C**

### INTERIOR

Stainless steel **C**

Stainless steel is AISI 304

## ALWAYS ON POINT

This series is often chosen by restaurants, production kitchens or food production facilities which require efficient and effective methods to chill down and freeze already portioned food - always on point, with taste and texture always perfectly protected throughout the entire process.

### USAGE AREAS



Catering Healthcare\* Education Hospitality Leisure

\*Food storage only, not for bio-medical purposes

### FOOD SAFE

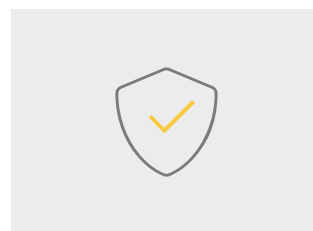

As soon as a user places food inside the blast chiller, a fully automatic time cycle starts. No action required - after the chilling process has finished, the device automatically shifts from 'chilling mode' to 'storage mode'.

### EASY CLEANING

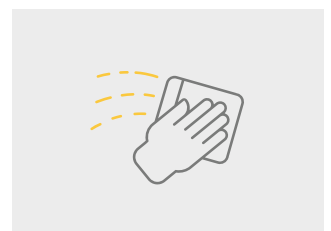

Durable and easy-to-clean stainless steel and smooth surfaces with rounded internal corners to keep the device hygienically clean. Evaporator and fan easily accessible. Both door gasket and shelf-support can be removed in an instant.

# SNOWFLAKE BLAST CHILLERS/FREEZERS



**SBU 15 HL**

CAPACITY  
 ❁ Chilling: 15 kg  
 ❁ Freezing: 8 kg  
 Rack: 5 positions for 1/1 GN



**SBU 20 HL**

CAPACITY  
 ❁ Chilling: 20 kg  
 ❁ Freezing: 12 kg  
 Rack: 5 positions for 1/1 GN



**SBU 20 HT**

CAPACITY  
 ❁ Chilling: 20 kg  
 ❁ Freezing: 12 kg  
 Rack: 5 positions for 1/1 GN

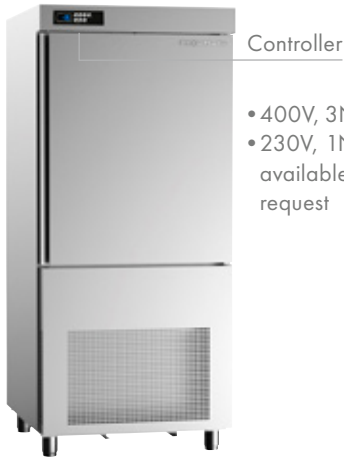

**SBU 40 HT**

CAPACITY  
 ❁ Chilling: 42 kg  
 ❁ Freezing: 25 kg  
 Rack: 10 positions for 1/1 GN

SERVING BAKERIES  
FOR **GENERATIONS**



## HANDLING OF DELICATE HIGH QUALITY BAKERY PRODUCTS

Generations of bakeries, confectioners and patisseries are trusting GRAM BAKER storage and process cabinets with their high quality bakery products. This is a great privilege and a daily inspiration for us. The GRAM BAKER range offers a complete series of refrigerators, freezers, quick chillers and provers.

Thanks to the GRAM air circulation system a correct and uniform temperature and humidity is ensured throughout the inside cabinet. The air is exhausted and refrigerated and then directed back into the inside cabinet, circulating around all food items. Thus, unwanted dehydration and skin forming of the goods is almost excluded.

*For successful  
baking traditions*



*3 generations of Gram Baker  
cabinets that have equipped  
European bakeries since 1991.*



# HANDLING YOUR BAKERY PRODUCTS WITH TECHNOLOGICAL INNOVATIONS



BAKER GA 950

## QUICK GUIDE

- ✓ Special features: ideal for bakeries, confectioners and patisseries
- ✓ High performance: perfect storage conditions despite frequent door openings
- ✓ Perfect fit: meets standard bakery tray size requirements
- ✓ BAKER 625, 550, 950, 1500, 1808/2408 Quick Chiller/Freezers (SF), Freezer-Retarder-Provers (GA): ideal for heavy-duty operations, rated with climate class 5 and suitable for the use in ambient temperatures of up to +40°C
- ✓ BAKER 610: ideal for normal-duty operations, rated with climate class 4, and suitable for the use in ambient temperatures of up to +30°C

### TEMPERATURE RANGES

M	F	SF	GA
-5/+12°C	-25/-5°C	-30/+10°C	-25/+40°C
Refrigerator, Storage cabinets and counters	Freezer, Storage cabinets and counters	Quick Chiller/Freezer	Refrigerator/Freezer/Prover

## INNOVATIONS IN DETAIL...

1. | Standard with coated evaporator; durable and saves costs later
2. | Controls concealed behind the top panel, protected against splashing water
3. | Standard models are supplied with an integral door lock
4. | Full length aluminium profiles impart additional strength and durability
5. | Removable door gasket for easy cleaning
6. | Self-closing door; remains open at opening angles more than 90°
7. | Support rails for bakery trays. These can be individually positioned
8. | Patented pedal door opener. Same opener can be placed left or right side

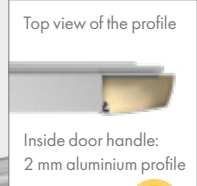

### USAGE AREA



Bakery, Confectioners and Patisseries

### LEGS, CASTORS OR PLINTH MOUNTING



**L1:** 100 - 130 mm - **L2 (standard):** 135 - 200 mm  
**C1 (standard):** castors 110 mm - **C2:** castors 125 mm  
 Prepared for plinth mounting at no extra charge.

#### PRESERVING QUALITY

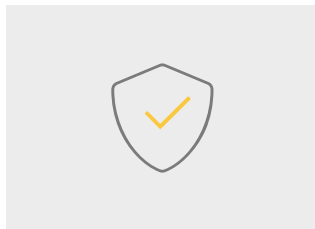

Both storage and process cabinets come with built-in functionalities that preserve the quality of your bakery products at all times.

Find more information on the following pages.

#### LOW-RUNNING COSTS

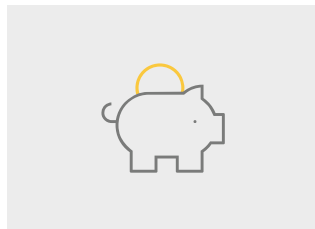

The energy-efficient refrigeration technology implemented in this wide line-up of storage cabinets can help saving running costs on a everyday basis.

#### BUILT-IN SAFETY

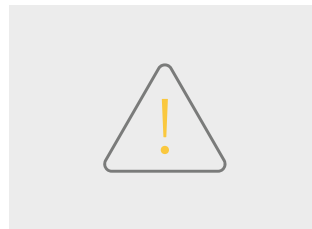

Controller equipped with safety functions: Door alarm, alarms for high temperature or when condenser filter cleaning is needed to avoid overheating. Controller perfectly protected from water splashes behind top panel.

#### MULTI-FUNCTIONAL

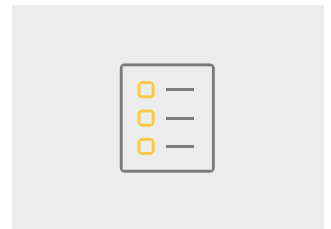

The SF can be used as quick chiller/freezer, storage freezer, storage refrigerator, or thawing cabinet. It is equipped with a dry cooling function. As required, The GA can also be used continuously as freezer, as refrigerator or as prover.

# PRODUCT LINE-UP

## STREAMLINED APPLICATIONS WITH ALL THE GRAM ADVANTAGES

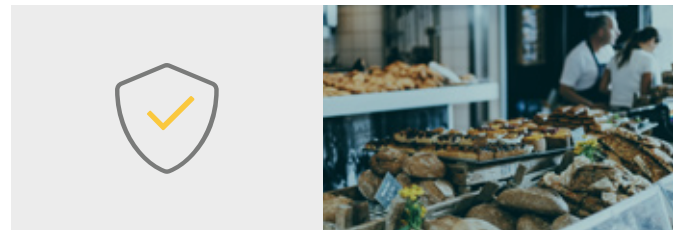

### MODERN DESIGN PRINCIPLES & INVENTIVE TECHNOLOGY

GRAM BAKER refrigerators and freezers are based on our award winning design principles and innovative solutions. Essential is an efficient air circulation system, providing indirect cooling and temperature stability and protecting your bakery products. Additionally, the electronic controls have safety functions for optimum protection.

#### REACH-IN OR ROLL-IN:

The BAKER range offers also roll-in cabinets. The BAKER 1500 series is available as refrigerator or freezer for bakery trolleys.

### PRESERVING YOUR QUALITY BAKERY PRODUCTS

Our refrigerators prevent any undesirable drying out of the bakery products thanks to indirect airflow of the air distribution system. You can use the dry cooling function for lower humidity (M cabinets), or use thawing function for controlled thawing.

Our refrigeration technology has been developed to prevent any undesirable quality loss of your products, such as drying-out of dough and cakes.



### MATERIALS & COMBINATIONS

#### EXTERIOR

Stainless steel **C**

Stainless steel **C**

White finish **L**

#### INTERIOR

Stainless steel **C**

ABS grey **ABS\***

Stainless steel **C**  
ABS grey **ABS\***

Stainless steel is nickel-free. \*Only BAKER 610

# GRAM STORAGE CABINETS & COUNTERS



**BAKER 610**

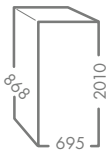

ENERGY RATING

- ☼ Refrigerator **C**
- ❄ Freezer **E**

Incl. **10** sets of bakery supports  
Tray size: 40 x 60 cm

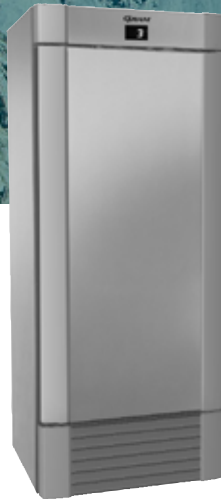

**BAKER 625**

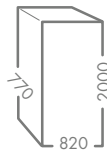

ENERGY RATING

- ☼ Refrigerator **B**
- ❄ Freezer **C**

Incl. **20** sets of bakery supports  
Tray size: 60 x 40 cm



**BAKER 550**

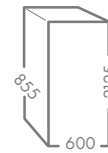

ENERGY RATING

- ☼ Refrigerator **B**
- ❄ Freezer **C**

Incl. **25** sets of bakery supports  
Tray size: 40 x 60 cm



**BAKER 950**

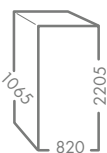

ENERGY RATING

- ☼ Refrigerator **C**
- ❄ Freezer **D**

Incl. **25** sets of bakery supports  
Tray size: 60 x 80/40 cm



**BAKER 1500 ROLL-IN**

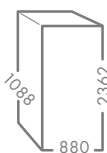

ENERGY RATING

Not yet regulated

For bakery trolleys



**BAKER 1808/2408 (2/3 sections)**

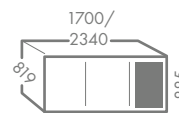

ENERGY RATING

- ☼ Refrigerator **E D**
- ❄ Freezer 1808 **D**

Incl. 2/3 x **9** sets of bakery supports  
Tray size: 40 x 60 cm

# PRODUCT LINE-UP

## WORKFLOW CONVENIENCE AND OPTIMAL PROCESS SUPPORT



### GA SERIES

The GRAM GA cabinet is a computer-controlled refrigerator/freezer/prover with individual program settings.

Set the GA to prove the dough outside working hours. The GA with its steam generator will automatically take the dough through all processes; from frozen or refrigerated dough to proved dough using your temperature, humidity and time settings. The air circulation system provides indirect cooling and temperature stability, protecting your bakery products. Skin-forming or drying-out of products can be eliminated almost entirely.

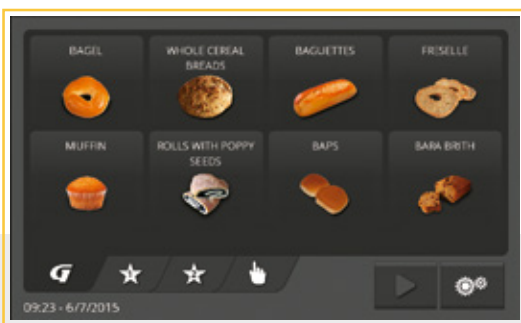

#### GA TOUCH DISPLAY CONTROLLER:

The 7-inch touch intuitive display controller is very easy to use and provides a clear overview of the current process status at all times. The operator can choose between 8 pre-set standard programs for easy start-up. Additionally, the intuitive controller allows manual program setting for individual adjustments.

### SF SERIES

The SF series comprises multi-functional cabinets. The SF can be used as quick chiller/freezer, storage freezer, storage refrigerator, thawing cabinet and with dry cooling function.

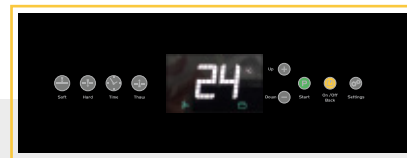

#### QUICK CHILLER/FREEZER CONTROLLER:

Multiple operation modes – use as quick chiller/freezer or choose refrigeration or freezing storage mode. The SF series features a large display, so the ongoing process is easy to monitor.

#### ROLL-IN FOR BAKERY TROLLIES:

The BAKER SF 1500 is a quick chiller/freezer for bakery trollies. The material used is stainless steel and it comes with a heated floor and a drive-in ramp.



## MATERIALS & COMBINATIONS

#### EXTERIOR

Stainless steel **C**  
Nickel-free

#### INTERIOR

Stainless steel **C**  
Nickel-free

# GRAM PROCESS CABINETS



**BAKER SF 550**

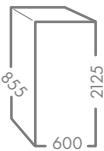

ENERGY RATING  
Not yet regulated

Incl. **25** sets of bakery supports  
Tray size: 40 x 60 cm



**BAKER SF 950**

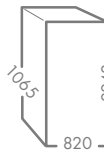

ENERGY RATING  
Not yet regulated

Incl. **25** sets of bakery supports  
Tray size: 60 x 80/40 cm

Not yet available  
with natural  
refrigerants



**BAKER SF 1500**

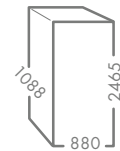

ENERGY RATING  
Not yet regulated

For bakery trolleys

Not yet available  
with natural  
refrigerants



**BAKER GA 550**

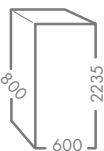

ENERGY RATING  
Not yet regulated

Incl. **25** sets of bakery supports  
Tray size: 40 x 60 cm



**BAKER GA 950**

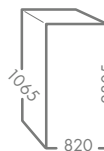

ENERGY RATING  
Not yet regulated

Incl. **25** sets of bakery supports  
Tray size: 60 x 80/40 cm



**MARINE**

**FOR THE  
DEMANDING  
CONDITIONS OF  
MARINE KITCHENS**



## RELIABLE, SAFE, STURDY

GRAM MARINE cabinets and counters are specially designed for the rugged needs of a working marine environment where reliability, performance and safety are the primary considerations. Upright cabinets, counters or under counters in different sizes and specifications.



### BUILT-IN SAFETY OF GRAM MARINE

All GRAM MARINE shelves are fixed to the supports to ensure no movement during heavy sea conditions, when the door is open. In calm seas the shelf can be turned easily allowing the shelves to be pulled out. Safe and convenient.



*Security in heavy seas*



# OUTSTANDING REFRIGERATION SOLUTIONS FOR MARINE KITCHENS



MARINE PLUS 70

## FRESHNESS IN DEMANDING ENVIRONMENTS: MARINE CABINETS AND COUNTERS

For decades, Gram has manufactured and supplied specialized refrigeration solutions for the offshore and marine sectors. These customers require our fully adapted models of the ECO MARINE series.

No matter what specification you require, Gram marine equipment – uprights and counters - provides reliable, safe and sturdy solutions.

- ✓ Designed for the rough conditions and work mode of a vessel kitchen, where reliability, performance and safety are the primary considerations. Insulation class: IP21
- ✓ With different footprint sizes and gross volumes from 125 to 614 litres, there is a cabinet for almost any professional galley. 230V/60Hz compressor as standard or 230V/50Hz at no extra costs
- ✓ Heavy duty, climate class 5: PLUS, TWIN and MIDI with insulated door
- ✓ Normal duty, climate class 4: COMPACT 210, 410 with insulated door, MIDI cabinets and with glass door
- ✓ Climate class 3: COMPACT 210 and 410 with glass door

### MARINE LEGS

130-200 mm. Can be fixed to the floor.

## KEY FEATURES: PLUS, TWIN AND MIDI

1. | Safe and cleaning friendly. Controls are concealed behind the top panel, perfectly protected against splashing water
2. | 50Hz or 60Hz compressor: This gives you maximum flexibility at no extra charge
3. | Food safe: temperature stability at all times, thanks to innovative air circulation system
4. | Easy cleaning: removable door gaskets for easy cleaning
5. | Specialized elements: dedicated locking marine handle
6. | Durable: sturdy stainless marine shelves with front and rear edge
7. | Anti-allergic materials: nickle-free stainless steel
8. | Easy wiping: Inside base with rounded corners and smooth surfaces help keeping the device hygienically clean
9. | Stability: marine legs can be fixed to the marine floor for maximum security



**MAXIMUM SECURITY AT HEAVY SEAS**  
All marine shelves are fixed to the supports to ensure no movement during heavy sea conditions. In calm seas the shelves can be turned easily allowing to be pulled out.



### USAGE AREA



Marine

### TEMPERATURE RANGES

K	M	F	F
+2/+12°C	-5/+12°C	-22/-5°C	-25/-5°C
Refrigerator	Fresh meat/ fish cabinet	Freezer*	Freezer**

\*COMPACT 210, 410 \*\* PLUS, TWIN, EURO, MIDI, GASTRO

**GLASS DOOR CONVENIENCE**  
Glass door alternative for good overview and convenience. Available for some cabinets.



## MATERIALS & COMBINATIONS

### PLUS, TWIN, MIDI, GASTRO

ALL SERIES

#### EXTERIOR

Stainless steel **C**

#### INTERIOR

Stainless steel **C**

### COMPACT

COMPACT 210, 410

#### EXTERIOR

Stainless steel **C**

#### INTERIOR

PS white **PS**

Stainless steel is nickel-free

# PRODUCT LINE-UP

## MARINE COUNTERS & CABINETS



### WORK TOP OPTIONS

1. | Insulation board (i.e. without work top)
  2. | Flat worktop without splashback
  3. | Flat worktop with 50 mm splashback
  4. | Flat worktop with 100 mm splashback
  5. | Saladette worktop with 50 mm splashback
  6. | Saladette worktop with or without night lid
- In addition, a rack with 2 shelves can be fitted onto the worktop.

### MARINE COUNTERS 1/1 GN - 2/3/4 REFRIGERATED SECTIONS

Refrigerators (K-models) have two drawer set options per section:

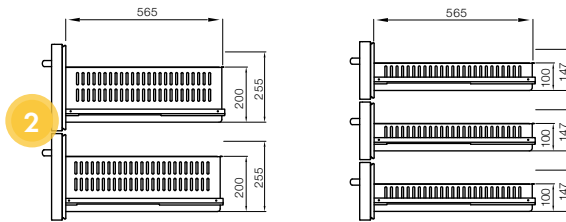

Counter tops are fitted with 'Marine edge' to prevent liquids from reaching the underlying cabinet.

### COMPACT CABINETS SMALL FOOTPRINT

COMPACT 210 and 410 – small footprint, only 595 x 642 mm



One piece polystyrene inner lining, easy to clean.



\*For more details see COMPACT section at page 22.

# GRAM MARINE COUNTERS & CABINETS



**COUNTERS 1407/1807/2207**  
(2/3/4 sections) 1/1 GN DEEP



2 sections: W 1289 - 4 sections: W 2163

1/1 GN DEEP  
SHELF 32.5 x 53 cm



**COMPACT 210/410**

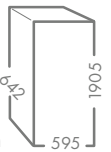

210: H 830 05

SHELF 48.6 x 43.3 cm  
BOTTOM 48.6 x 30 cm



Top-mount  
compressor

**MARINE PLUS 70**

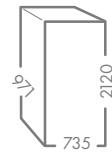

Dim. including handle

2/1 GN DEEP  
SHELF: 53 x 65 cm



Top-mount  
compressor

**MARINE TWIN 82**

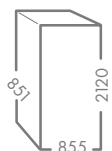

Dim. including handle

2/1 GN WIDE  
SHELF: 65 x 53 cm



Bottom-mount  
compressor

**MARINE MIDI 60**

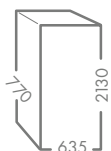

Dim. including handle

SHELF: 43.5 x 53 cm



Bottom-mount  
compressor

**MARINE MIDI 82**

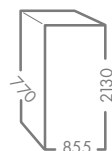

Dim. including handle

2/1 GN WIDE  
SHELF: 65 x 53 cm





WHAT INSPIRES ME ABOUT  
BEING A **BARTENDER** IS  
THE ENDLESS POSSIBILITIES  
IN TASTE AND TEXTURE

*Tess Posthumus*



## PREMIUM ICE FOR ALL PURPOSES

As a fully integrated manufacturer and supplier of commercial refrigeration solutions and ice makers, we are proud to have built a comprehensive portfolio of ice makers, suitable for all types of businesses and purposes.

Our product line up ranges from Cubers, Flakers, Nugget and Crescent ice makers to Special ice makers, producing extraordinary ice shapes such as ball ice, heart ice or star ice.

Hoshizaki ice makers continuously excel in meeting even the highest hygiene and contamination protection standards. That is why Hoshizaki ice can not only be found in bars, restaurants, supermarkets and hotels, but also in healthcare facilities; hospitals, laboratories and research institutions all over the world.

*“For a perfect cocktail  
I want to use only clear,  
hard and tasteless ice.”*

### **Tess Posthumus**

Co-Owner of Flying Dutchman Cocktails  
Amsterdam and Hoshizaki Ambassador



*“One of the most essential elements to recovery for a professional diver is ice.”*



## ICE AIDS RECOVERY AT DIVE LONDON AQUATICS CLUB

Jane settled at Dive London in 2014, after having coached diving teams all around the world. As an experienced coach, she knows how vital the recovery phase is for the divers. An integral part of the recovery is eliminating muscle soreness, for instance by keeping the muscles cold in order to limit the swelling. This is especially beneficial for divers who engage in the '10 metres'.

From big names such as Tom Daley, Grace Reid, and Robert Birch to the up and coming juniors of the Club - Hoshizaki ice became indispensable for every-day training days as well as competition days at Dive London.



*“We fill small bags with ice, and use cling film to hold it tightly in place, generating a cold compression on the triceps and legs in particular. Left for 15-20 minutes, the ice really does deliver significant benefits to our team.”*



# LONDON AQUATICS CENTRE

## QUEEN ELIZABETH OLYMPIC PARK, LONDON

### Establishment

London Aquatics Centre, home to the Dive London Aquatics Club

### Facilities

A one-stop shop for our athletes, with two indoor competition pools, a diving pool and state-of-the-art fitness facilities with a physio, therapy and rehab area

### High Performance Head Coach

Jane Figueiredo

### Opening year

As a legacy of the 2012 Summer Olympics and Paralympic games, facilities opened to the public on the 1st March 2014

### Hoshizaki equipment

IM-45CNE Cuber

The centre is home to the Dive London Aquatics Club, which in conjunction with British Diving, offers a pathway for individuals looking to progress from the Tom Daley Diving Academy through, competing regionally, nationally and internationally. The club represents 72 divers (2018) with experience ranging from club level through to Olympic standard divers.



Before the Hoshizaki Cuber was installed, Jane and her team had to pre-order ice with external suppliers. Now, with their own ice maker they can rely on quality ice, on demand, at all times. This alone is a great asset, not only for training, but as well as competitions and events.





*“The value Hoshizaki adds to the experience of my guests, far outweighs the initial investment.”*



## PRETTY DRINKS IN BEAUTIFUL GLASSWARE ...PERFECTLY CLEAR ICE

“Hoshizaki is the only company I’ve worked with that delivers a very consistent product, which I want and need - clear ice, every single time.”

“Supreme clarity is vital for the look of the finished drink. If the ice looks fantastic, it will showcase any of the wonderful products you choose to pair.”

Myles can look back on more than 20 years in the bar and drinks industry. Since his beginnings in mixology, he has been working with Hoshizaki ice makers exclusively, becoming a real Hoshizaki connoisseur over time.

“The machines are extremely reliable so they do not need regular attention, but service is always prompt and highly efficient”, the bar owner and bar consultant concludes.





## THE MIXOLOGY GROUP

### BRIGHTON, ENGLAND

#### Specialty

A drinks consultancy & training company

#### Establishment address

Rear of 64 Davigdor Road, Brighton

#### Founders

Myles Cunliffe set up the Mixology Group with his wife Zoe

#### Opening year

2010

#### Hoshizaki equipment

IM-240ANE-HC ice maker,  
IM-65NE-Q Ball Ice maker

The Mixology Group specialises in training staff in all aspects concerning the bar business, from mixology and cocktails to bar tending and becoming a certified 'Whisky Ambassador'. The company also partners with big brands of new drinks when it comes to research & development of new beverages, mixtures and combinations. Last but not least, The Mixology Group has made a name as a reliable provider of bar staff to all sorts of events, parties and celebrations.



When speaking about the importance of ice, Myles explains: "People underestimate the importance of truly great ice. As half the volume of the glass is made up of it, it is essential to have the clearest, densest ice possible. Watery, cloudy ice is simply not acceptable in a well made drink."



You will find two ice makers in the Brighton Bar "The Mixology Group", the classic IM Cuber and the famous Ball Ice Maker. "This is not only for the looks", explains Myles, "as with less surface area than square ice, round ice reduces melting time even more. And it looks spectacular in the glass."



*“When it comes to ice making machines, we wouldn’t touch anything else.”*

## TRIPLE FILTERED SCOTTISH WATER & THE VERY BEST MACHINES

Supplying pre-bagged cubed and crushed ice in a choice of large 12 kg, or smaller 2 kg sealed bags, The Edinburgh Ice Co. offers delivery to anywhere in the UK.

Using a bank of sixteen Hoshizaki IM240 ice makers, the team can produce up to three tonnes of cubed ice per day at maximum capacity.

“Of course, we could use big, machines for mass ice production, but they simply don’t deliver the same results when it comes to quality of the ice. We’re all about the quality and will not compromise on anything less than a perfect ice cube or nugget.”





## THE EDINBURGH ICE COMPANY

### EDINBURGH, SCOTLAND

#### Specialty

Ice cubes for the hospitality and events sectors

#### Opening year

2014

#### Establishment address

1 Summerhall Pl, Edinburgh

#### Hoshizaki equipment

Sixteen Hoshizaki HC Cubers

IM-240ANE-HC

#### Founders

Ilanna Middleton and Rhys Ferguson

Started by a passionate duo, looking to fill a niche in the market for quality ice, the Edinburgh Ice Company initially started out by supplying bars, restaurants, hotels, festivals and events with ice for beverage making. With extensive experience of working in events and hospitality from their previous roles, Ilanna and Rhys had a solid prior knowledge of our city and its bars, pubs and high-profile events.



A talent for sculpting ice has unlocked opportunities around the country, especially as the only artisan ice carvers in Scotland.

Describing their business model, the owners explain: "We come to the rescue, when a bar or any other larger venue experiences a downtime or malfunction of their ice maker. Also, we supplement with highest quality ice, in the case of unexpected peak times and rush hours."

"We're super proud that we only use Hoshizaki machines for our cubed and crushed ice. In fact, we're so delighted; we put the Hoshizaki on our vans, uniforms, website, merchandise and in our social media content", Ilanna concludes.



# THE SIX SIDES OF CHILLING PERFECTION

## MEET THE HOSHIZAKI CUBE

Every bartender will tell you about the importance of the ice quality for their craft of creating layers of taste and texture in a cocktail glass. Premium spirits and ingredients simply ask to be paired with nothing less than ice cube perfection. Hoshizaki cubes are extremely compact, dry, tasteless, consistently identical and slowly melting, allowing just the right amount of dilution – a combination of everything a bartender requires when it comes to aesthetics, taste and functionality of ice.

### THE MARBLE EFFECT:

The appearance of the Hoshizaki cube is characterized by its clean edges and its transparency streaked by a marbling effect. This effect occurs, when the **CELL WALLS** block the freezing water's expansion from all sides, while reaching up to  $-30^{\circ}\text{C}$  during the cubing process. As the temperatures decrease, the water keeps expanding and marbles start to form as a sign of extreme density and compactness of every single cube.

We are proud to provide and continuously perfect the technology behind these dense, dry and exceptionally hard ice cubes. As the cubes are formed individually inside **A CLOSED-CELL SYSTEM**, there is no unpleasant bridging between the single cubes.

### CUBE SIZES

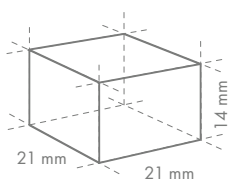

Cube size: **XS**  
Weight: 6 g

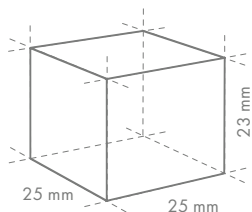

Cube Size: **S**  
Weight: 13 g

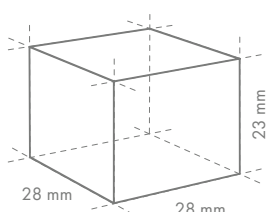

Cube Size: **M**  
Weight: 17 g

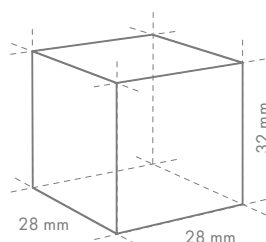

Cube Size: **L**  
Weight: 23 g

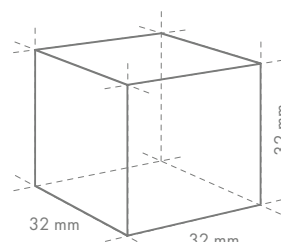

Cube Size: **XL**  
Weight: 31 g



## WHEN CREATING THE WORLD'S MOST POPULAR ICE CUBES, THERE ARE THREE MAJOR CHARACTERISTICS THAT COME INTO PLAY:

### PERFECT TASTE



Being free of all impurities, our cubes are a perfectly tasteless chilling agent for all types of culinary purposes without compromising the taste of your creation.

### PERFECT SHAPE



Each cube is made individually by a dedicated spray of fresh water within a closed cell to achieve the highest possible compactness of an ice cube with the perfectly precise square shape.

### PERFECT DILUTION



During the freezing process, the cell walls block the freezing water's expansion from all sides. This makes Hoshizaki ice cubes so exceptionally compact and hard, that they provide the exact rate of dilution needed for cocktails and long drinks.

### USAGE AREAS



Hospitality



Catering



Healthcare



Leisure



Marine



Education



Foodprocessing

## LET'S COMPARE! UPGRADE NOW – AND CUT YOUR RUNNING COSTS!

Save up to  
**40%**

	COMPETITOR 1	COMPETITOR 2	IM-30CNE-HC
⚡ Energy consumption	400 W/h	290 W/h	230 W/h
💧 Water consumption	0.09 m <sup>3</sup> /24h	0.13 m <sup>3</sup> /24h	0.07 m <sup>3</sup> /24h
<i>Total costs after 8 years*</i>	<b>£ 4,814.-</b>	<b>£ 4,049.-</b>	<b>£ 2,926.-</b>

	COMPETITOR 1	COMPETITOR 2	IM-240DNE-HC
⚡ Energy consumption	1850 W/h	1400 W/h	930 W/h
💧 Water consumption	0.37 m <sup>3</sup> /24h	0.40 m <sup>3</sup> /24h	0.32 m <sup>3</sup> /24h
<i>Total costs after 8 years*</i>	<b>£ 21,866.-</b>	<b>£ 17,585.-</b>	<b>£ 12,150.-</b>

We have compared our HC models against competitor models with identical production capacities.

\*Electricity à £ 0.144/kWh - Water à £ 2.96/m<sup>3</sup>

## PRODUCT LINE-UP

# THE DURABLE & DEPENDABLE HIGH PERFORMERS

## ABOUT THE RANGE

All Cubers are equipped with an electronic control system. This ensures an optimized ice making process, even under varying circumstances. Without additional manual assistance or adjustments required, our Cubers produce generous amounts of ice cubes, at a consistent high quality. As all impurities are eliminated from the water right at the beginning of the cubing process, the problem of malfunction due to calcification, mineral accumulation and incrustation is almost unknown to owners of Hoshizaki Cubers. Thanks to natural refrigerant R290, all Cubers have an improved energy performance. Furthermore, naturally occurring HC refrigerants only have

a minimal global warming potential, compared to machines run with traditional HFC refrigerants. This has a positive impact on both the environment and your budget. As with all Hoshizaki ice makers, the Cubers are HACCP certified and known for continuously meeting the highest health, safety and hygiene standards.

As Hoshizaki Cubers come in multiple self-contained, modular and stackable options, the series is considered to be a true allrounder - suitable for all requirements, purposes, locations and budgets.

### STABLE MATERIALS AND DURABLE DESIGN



The devices are designed to last and come with smart design extras such as a magnetic water pump without direct coupling. This element prevents leakage from the water circuit and improves the life expectancy of the device.

### LOW ENERGY CONSUMPTION



The use of natural HC refrigerant R290 cuts down the overall energy consumption of our Cubers significantly.

### RANGE PRODUCTION CAPACITY



The series consists of Cubers with production capacities, ranging from 22 - 240 kg per day.

### HIGHEST HYGIENE STANDARDS & EASY MAINTENANCE



The exteriors are made of stainless steel. Also the closed water circuit provides maximum protection against any type of contamination during the entire cubing process. All Hoshizaki machines are easy to use, clean and maintain.

Water cooled  
models  
COMING SOON



Self  
contained

### IM-21CNE-HC



Production capacity/24 h\*:  
25 kg  
Bin capacity: 11.5 kg  
Cube Size: **L**



Self  
contained

### IM-65NE-HC



Production capacity/24 h\*:  
62 kg  
Bin capacity: 26 kg  
Cube Size: **S L**



Self  
contained

### IM-100CNE-HC

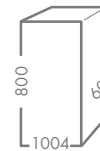

Production capacity/24 h\*:  
105 kg  
Bin capacity: 38 kg  
Cube Size: **M L XL**



Self  
contained

### IM-240NE-HC



Production capacity/24 h\*:  
210 kg  
Bin capacity: 110 kg  
Cube Size: **L**



Modular

### IM-240ANE-HC



Production capacity/24 h\*:  
210 kg  
Cube Size: **XS M L XL**



Stackable

### IM-240DNE-HC



Production capacity/24 h\*:  
210 kg  
Multiple machines can be stacked  
Cube Size: **XS M L XL**

\*Unless stated otherwise the indicated production capacity refers to the amounts produced by models with standard ice cube size L

# MAXIMUM VERSATILITY FOR ENDLESS APPLICATIONS

## FLAKE AND NUGGET ICE MAKERS

Our Flake and Nugget ice makers belong to the true allrounders of the Hoshizaki product line-up. These powerful, durable and sustainable machines are highly popular across different market segments, such as in food preparation/processing, as well as in hotels, bars, restaurants and catering businesses.

As the Flake and Nugget ice makers convert all water brought into the machine, the water consumption is equal

to its ice production. Additionally, all Flake and Nugget ice makers use the natural refrigerant R290, which is environmentally friendly and energy efficient.

Being proven free of all impurities and meeting even the strictest hygiene requirements, Hoshizaki flake ice is even used for organ transport and other medical purposes.

## ICE-TO-WATER RATIO

The main characteristic of Hoshizaki's flake ice is that 'freeze burn' is prevented when displaying fresh fish or produce. The extruding head inside the Flaker exerts only a slight compression, producing the typical Hoshizaki ice flakes.

For Nugget ice, the extruding head performs a higher compression to yield **harder and dryer, individual** ice nuggets.

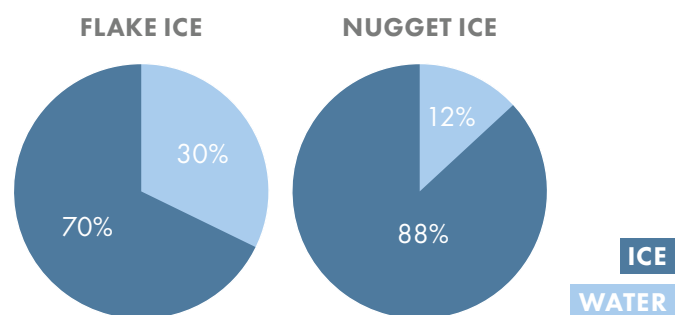



# ABOUT FLAKE & NUGGET ICE

## PERFECT TASTE AND HYGIENE



Being free of all impurities, our flake and nugget ice is a perfectly tasteless chilling agent for all types of culinary purposes. This factor makes this ice very popular for medical applications as well.

## VERSATILITY



Hoshizaki ice makers can produce either flake or nugget ice. Both ice types are highly versatile and a staple for different market segments and business types, such as; hotels, food production, bars and restaurants.

## SUSTAINABILITY



All Flakers and Nugget ice makers use natural refrigerant R290, which is environmentally friendly and energy efficient. Additionally, it converts all fed-in water into ice and is therefore a device that can help you save water with every cycle.

## USAGE AREAS



Hospitality



Catering



Healthcare



Marine



Foodprocessing



# THE POWER TO CHILL - INDISPENSABLE ALL-ROUNDERS

## ABOUT THE RANGE

An important design element of our Flaker technology is the extremely sturdy auger - the hardest working element of any flake ice maker. The inner workings of the Flake and Nugget ice makers is designed to prevent unpleasant incrustation, calcification and bacterial contamination inside and around the machine.

The auger is made of stainless steel, while carbon is used for the bearings. The durable materials used in their production help the machines to work optimally in wet and rough environments and allows proper and easy cleaning routines.

Benefits include: longer product life expectancy and reduced maintenance costs.

Hoshizaki ice makers have micro computer controls, monitoring the ice making process to perform at its best under varying circumstances, without having to make physical adjustments. An easily cleanable air filter allows operators to carry out frequented cleaning routines, which extends the product life expectancy and reduces the frequency and costs of maintenance call-outs.





Self contained



### FM-80KE-HC/HCN



Production capacity/24 h:  
Flake: 85 kg - Nugget: 75 kg  
Bin capacity:  
Flake: 26 kg - Nugget: 32 kg

Self contained



### FM-120KE-HC/HCN



Production capacity/24 h:  
Flake: 125 kg - Nugget: 110 kg  
Bin capacity:  
Flake: 26 kg - Nugget: 32 kg

Self contained



### FM-120KE-50-HC/HCN



Production capacity/24 h:  
Flake: 125 kg - Nugget: 110 kg  
Bin capacity:  
Flake: 57 kg - Nugget: 65 kg

Modular



### FM-150AKE-HC-SB/HCN

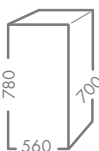

Production capacity/24 h:  
Flake: 150 kg - Nugget: 140 kg

Modular



### FM-300AKE-HC/HCN-SB

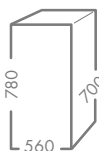

Production capacity/24 h:  
Flake: 300 kg - Nugget: 250 kg

Modular



### FM-480AKE-HC-SB/HCN-SB

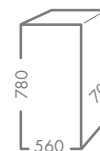

Production capacity/24 h:  
Flake: 450 kg - Nugget: 380 kg



DISCOVER THE  
NEW GENERATION

UNIQUE PURITY - HOSHIZAKI'S SIGNATURE ICE ...  
WITH AN EDGE

Just like the original Crescent ice makers, the new generation with the 'Edge' produces clear, crescent shaped ice. The unique shape is built from the inside out with an internal temperature of -4°C and can be used for chilling drinks, produce and bottle display, as well as for cooking.

One of the most striking features of our Crescent Edge ice is its round form and the flat bottom with two small winglets. This form behaves as the perfect drink chiller, as it is tasteless, absolutely clear, and slowly-melting.

Thanks to its rounded, yet edgy form, Hoshizaki Crescent ice will also not cluster inside the ice chest, always ready to be scooped out easily for immediate use.

CRESCENT ICE

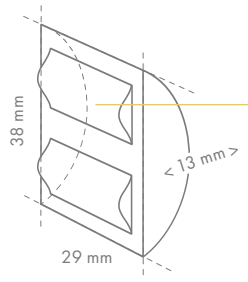

KM Edge Cube  
Weight: 10 g

The Crescent ice has **winglets**. Other than that, it has the same characteristics as the old version of KM. (i.e. Clarity, pureness, temperature, roundness)



# ABOUT CRESCENT ICE



## DAMAGELESS BOTTLE COOLING

The ice is hard and compact, but thanks to the smooth, round surface it is the ideal ice type to prevent damages to bottles and labels.



## APPETIZING DISPLAY

Due to the crystal clear ice, you can present your produce completely covered and perfectly protected, but still visible to your customer.



## CHILLING DRINKS

Due to 0% impurities, the ice is perfectly tasteless and the optimal base for your cocktail creations.



## OPTIMAL ICE TEMPERATURE

The temperature of the ice is exactly 0°C cold, hence unpleasant 'freeze-burns' are prevented. The ice is completely clear, allowing the produce to be covered entirely, which helps to maintain optimal temperatures around your vulnerable and delicate foods.



## THE EDGE

The most unbeaten characteristic of Hoshizaki's Crescent ice is its unique form which allows splash-free serving of post mix soft drinks, whilst being the most economical ice, as it offers an optimal drink displacement.



## NO CLUSTER

Round edges of the ice prevent clustering when keeping it in buckets for beverage cooling or in a fresh meat, fish or buffet display. Fresh produce or buffet bowls can be rearranged constantly, without any compromises on texture or taste of the produce.



## USAGE AREAS



Hospitality



Catering



Healthcare



Food-processing



Marine



## EVERCHECK

- Specifically developed for the Crescent ice makers
- Visible and audible alarm when maintenance assistance is required
- Main service and maintenance routines can be carried out through the front access
- Controls are located in a dry environment, greatly improving electrical component reliability



## CYCLES AVER

- Hoshizaki's Crescent ice makers produces the same quantity of ice in half as many cycles
- Fewer cycles per day results in increased longevity and profits
- Reduced operating cycles by half, while producing the same quantity of ice compared to competitors

## HOSHIZAKI'S SIGNATURE ICE TYPE

### ABOUT THE RANGE

The double-sided evaporator in all our Crescent ice makers is made of stainless steel - the best material for improved longevity, food safety and damageless cleaning.

With the increased ice-to-steel surface of the improved evaporator, the Crescent Edge ice makers even outperforms the powerful earlier generation, when it comes to harvest cycles and production capacities. The compact parameters of the self contained models makes it a perfect fit for small spaces. Furthermore, the smart plug-and-play design guarantees the extremely easy and quick set-up.

Always focusing on operating convenience and food safety, all units (including the air filter) are easily accessible from the front. Keep in mind that frequent cleaning routines will improve the longevity of your machine.

The fully automatized, digitally controlled ice making process requires no manual adjustments and can be a true time saver for your staff.

#### DOUBLE PRODUCTION



The improved double evaporator with its double-sided, stainless steel surface makes the same amount of ice in half the time.

#### MAXIMUM HYGIENE



The compartmentalized interior of the ice maker is a smart design feature to boost the food safety, as it protects the water circuit from any outside contamination.

#### FLEXIBILITY



Need to amp up your production capacity? The variable setup with modular bins and bases allow the user to mix and match depending on individual requirements and conditions.

# CRESCENT ICE MAKERS



Self contained

## KM-40B



Production capacity/24 h:  
43 kg  
Bin capacity: 16 kg



Self contained

## KM-55B



Production capacity/24 h:  
53 kg  
Bin capacity: 23 kg



Self contained

## KM-80B



Production capacity/24 h:  
79 kg  
Bin capacity: 40 kg



## KMD-210AB-HC

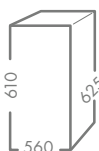

Production capacity/24 h:  
210 kg



# PAIRING AESTHETICS AND FUNCTIONALITY

## EYE CANDY FOR YOUR DRINKS

Expand your creative horizon and your craft's aesthetic possibilities with the help of our Special ice makers that produce different, extraordinary shapes of ice.

Specially tailored for cocktail bars that like to differentiate themselves from others, whilst never compromising on taste and quality of their drinks. With perfect ice characteristics still in focus, you can now add a decorative highlight to your cocktails and long drinks.

Our Special ice makers work, similar to our famous Cubers, with our patented closed-cell system.

Each ice shape is made individually by a dedicated spray of fresh water. This happens within a closed cell to achieve the highest possible compactness of an ice cube with the perfectly precise shape of a ball, star, heart, cylinder, big cube or long cube.

Owners of a Hoshizaki Special ice maker can look back on times of manually molding single ice forms. Now, they enjoy the convenience of scooping absolutely identical ice shapes from the built-in and easily accessible storage container.

### SPECIAL ICE

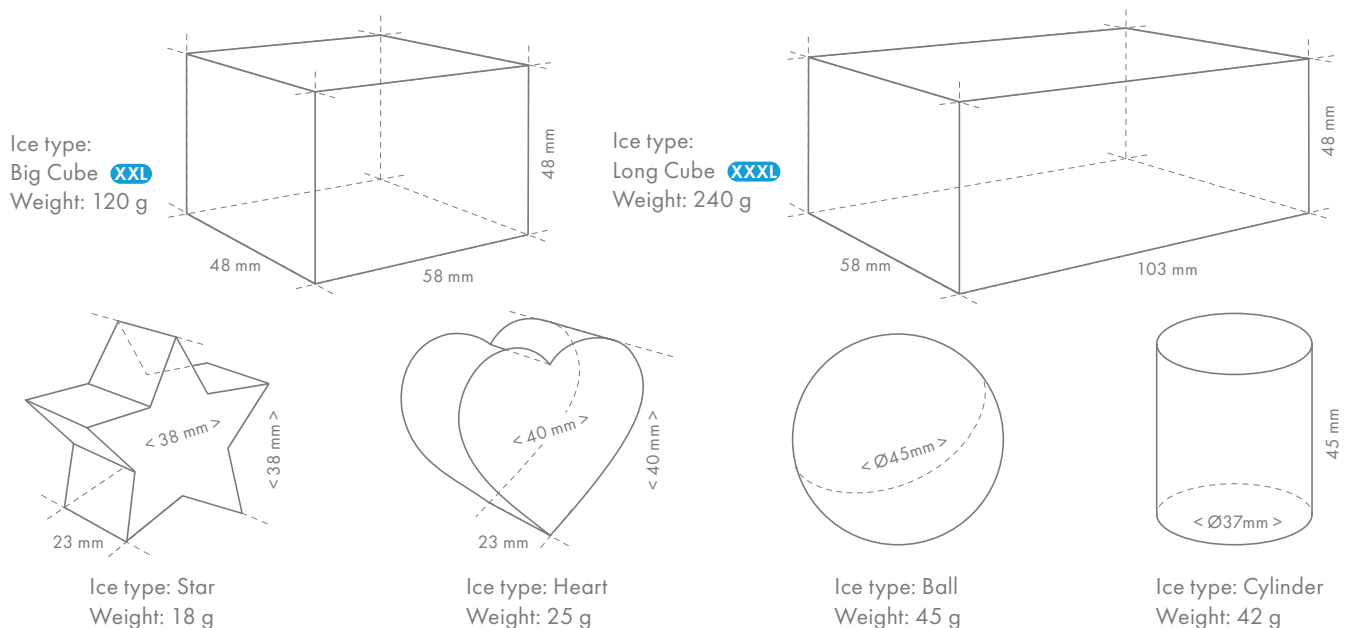

# SPECIAL ICE MAKERS

Stackable



Self contained



*“Hoshizaki is a market leader when it comes to ice, but more than that, they are an inspirational brand ... creating ice in a different form, that allows you to be more creative behind the bar.”*

**Andrew Mullins**

Operations Director  
Fling Bar Services Dubai (UK/UAE)  
September 2018

## IM-65NE-HC-Q BALL ICE MAKER



Production capacity/24 h:  
22 kg  
Bin capacity: 26 kg  
Ice type: Ball

## IM-240DNE-C CYLINDER ICE MAKER

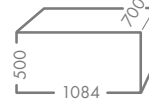

Production capacity/24 h:  
240 kg  
Ice type: Cylinder

## USAGE AREAS



Hospitality



Catering



Education



Leisure



Marine

Big Cube



Ball Ice



Heart-shaped Ice



Star-shaped Ice



# THE RAPID FRESH MAKERS

## WATER & ICE – IS THERE A BETTER TEAM?

Dispensers play a crucial role when business owners want to provide ice and/or water for self-service. The three steps of quality ice production, protected ice storage and the quick service of ice are all combined in one device – with the help of only one button your refreshment is ready in seconds.

With **DCM DISPENSERS** the user can select from these options:

- Cubelet ice only
- Cubelet ice and water
- Water only

The production capacities of these compact, yet powerful ice/water dispensers range from 60 kg a day for smaller businesses to up to 230 kg a day for sizable venues, such as amusement parks, hotel resorts and large-scale quick serve environment.

Most commonly, Hoshizaki dispensers are used, where a quick, efficient, and food-safe serving of ice-water combinations is needed.

**DIM DISPENSERS** produce and provide the famous Hoshizaki cubes for handy self-service. What makes this dispenser so popular is its convenient portion control, which can be set easily. This allows you to precisely regulate the serving sizes. This range of self-serve dispensers is often placed in hotels, positioned on each floor, to provide guests with quality ice all around the clock.

With an elegant and lean look, they almost disappear within modern interior designs. Focusing on user-friendliness and maximum food safety, air or light never hits the freshly produced ice, while stored, providing maximum contamination protection for operators and consumers.

**DSM DISPENSERS** are compact and reliable appliances that produce and serve high quality shuttle ice. The simple design and smart features, for food safety and against contamination, make DSM dispensers popular for hospitals and health care institutions.

### DISPENSERS ICE

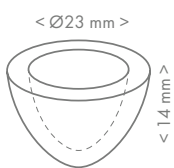

Ice type: Shuttle  
Weight: 3 g

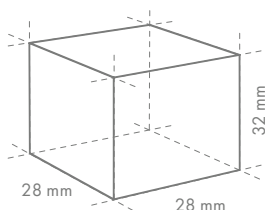

Cube Size: **L**  
Weight: 23 g

### USAGE AREAS



Hospitality



Catering



Healthcare



Education



Marine

# ICE AND/OR WATER DISPENSERS



**DSM-12DE ICE**

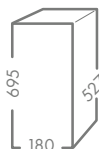

Production capacity/24 h:  
13 kg  
Bin capacity: 3 kg  
Ice type: Shuttle



**DIM-40DE-HC ICE**

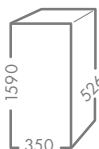

Production capacity/24 h:  
43 kg  
Bin capacity: 15 kg  
Ice type: Cube **L**



**DCM-120KE(EU) ICE & WATER**



Production capacity/24 h:  
125 kg  
Bin capacity: 1.9 kg  
Ice type: Cubelet & Water

## EASY FIT



Our dispenser portfolio accommodates suitable appliances for different requirements regarding serving amounts, storage capacity and space limitations.

## SUSTAINABLE



Waste control for more sustainability; these dispensers allow intuitive portion control. This helps to regulate the consumption of ice among end-user, reducing overall energy consumption and waste.

## FOOD SAVE



As with all Hoshizaki machines, hygiene, food safety and contamination protection play a major role. Dispensers are operated by consumers directly. In order to eliminate health risks, the machines are designed to never let air or water hit the freshly produced ice, while stored.

## BEER DISPENSER



**THANKS TO THE SPEED & RELIABILITY  
OF THE BEERMATIC DUAL TAP WE  
ARE ABLE TO SERVE BEERS TO LARGE  
PARTIES AT A FASTER RATE, WHICH  
ALLOWS TIME FOR A BARTENDER  
TO FOCUS ON PROVIDING A TOP  
QUALITY CUSTOMER SERVICE**

*Giovanni Derpergola - Bar Consultant @Liquidalembic*



## AUTOMATION NEVER TASTED THIS GOOD

Multitasking is a key skill of every bartender. From taking orders, preparing cocktails and other drinks, processing payments and keeping the workspace clean to ensuring guests have their full attention and create a positive atmosphere. The BEERMATIC DUAL TAP is a fully automatic draft beer dispenser with a mechanism that also pours the head of the beer. The hands-free portion control allows a preset quantity of chilled draft beer and the head of the beer to be served - always at the perfect temperature. Beer after beer after beer.

*Don't accept waste!*

*Less waste with  
Hoshizaki BeerMatic  
technology*

**The BEERMATIC is a great tool for cost control. Portions can be controlled accurately, without spillage of beer and/ or the head of the beer. Waste of draft beer is generally estimated to be as high as 20% per keg.<sup>1</sup>**



# PERFECTLY POURED BEER AT THE TOUCH OF A BUTTON

## CONSISTENTLY HIGH QUALITY BEER



The beer-to-head ratio can be adjusted to different types of beer or to meet local preferences. The system has the dispensing capacity of 65 litres, which means it can pour 130 perfectly chilled beers (0.5 ltr.) consecutively. An internal cooling system chills down the beer on its way from the keg through the machine, so that the draft beer can be served directly from ambient temperature kegs.

## INCREASE REVENUE



Until the beer is poured, no additional attention is required. This creates time for additional tasks such as; processing payments, preparing orders or to clean up. These saved seconds seem marginal, but when serving large amounts of people, automated work-sharing becomes a measure for efficient crowd serving.

## EASY TO FIT IN & INSTALL



The BEERMATIC is a space-saving device, as no additional refrigerator for the beer keg is needed. With its compact design and small footprint, this countertop dispenser fits into multiple environments. It can also be easily transported and installed for pop-up events and outdoor venues.

## FUNCTIONAL FEATURES

### 1. PRESS ONCE TO DISPENSE

It's as simple as that. Press the dispense button once to draft the preset amount of beer.

### 2. TILT-POURING

The dispense operation is tilting the glass to the right angle to ensure perfectly poured beer.

### 3. PORTION CONTROL

The portion size can be preset to pour the same quantity every time, meaning no overflow.

### 4. HEAD OF BEER CONTROL

The head of beer portion can be set and adjusted for both taps individually.

### 5. INTERNAL COOLING SYSTEM

Ambient temperature beer is cooled down as it flows through the beer circuits.

### 6. TWO BEER CIRCUITS

This dual-tap model has two circuits, so two different types of beer can be connected and poured simultaneously.

### 7. COUNTING/LOG FUNCTION

The display shows the number of beers poured. Via the user settings, you can configure the number of beers, based on the volume of your glasses.

### 8. AUTOMATIC OR MANUAL DISPENSE MODE

It is a simple process to switch from automatic to manual dispense mode or vice versa via the operation panel.



### 9. EMPTY-KEG-ALERT:

A "SOLD OUT" lamp lights up in the control panel as soon as there is less than 0.5ltrs. left in the beer circuit.



## HYGIENE AND FOOD SAFETY



Accurate portioning avoids spillage entirely, no cutting/skimming needed, and the workspace remains clean at all times. The dispenser's compartmentalized design is engineered to avoid contamination and to simplify cleaning routines. With this system you can reduce the glass-to-person contact points and maintain the highest standards of food safety, hygiene, and sanitization.

## COST REDUCTION



The BEERMATIC is a great tool for cost control. Portions can be controlled accurately, without spillage of beer and/or the head of the beer. Waste of draft beer is generally estimated to be as high as 20% per keg<sup>1</sup>. The internal refrigeration system allows you to store all of your kegs at ambient temperature which saves you energy costs and additional costs for a cold room or fridge.

## OPERATIONAL FLEXIBILITY



Offering great flexibility, the dual tap allows you to connect two separate kegs with different types of beer at the same time. Additionally, the automatic tilting unit is compatible with all standard glass sizes. As the compact dispenser can be transported and installed easily, and because it doesn't require additional cooling, it is a great option for outdoor/temporary events.

## PRODUCT LINE-UP

# FASTER, SMARTER, CLEANER

## LESS WASTE WITH HOSHIZAKI BEERMATIC TECHNOLOGY

### NO OVERPOURING

Overpouring is a real cost factor and the added spillage can cause significant losses. Thanks to the accurate portion control function, this problem is eliminated.

### NO WASTE

As soon as a keg gets too warm, excess carbon dioxide is released, which increases the head of the beer size. The beer will become slightly sour and even cloudy. The BEERMATIC's internal cooling system will help reduce the waste on the head of the beer from the beginning.

### LESS STALE BEER

Keeping close track of beer sales reduces the overall problem of stocking beer that no one wants. A built-in counter in the display helps you keep an eye on real-time beer sales and provides the ability to track consumption trends overtime.

### UNTAPPING ONLY EMPTY KEGS

Untapping a keg too early occurs because bartenders don't know if –or how much – beer is left in the keg. The BEERMATIC has an indicator showing when the keg is getting empty, eliminating guesswork, and helping you sell every last drop.

### IMMEDIATE USE



Unlike traditional drafting systems that require beer kegs to be refrigerated for 24 hours before connecting to the tap, the BEERMATIC cools down each portion individually on its way from the keg into the glass.

### HEAD OF BEER CONTROL

The beer to head ratio can be manually adjusted depending on local preferences and beer type.

### PERFECT TEMPERATURE

The beer is poured into the glass at a controlled temperature between 2 - 8 °C.



### EASY TO SET, OPERATE AND CLEAN



# BEERMATIC DUAL TAP

## HIGHLY COMPATIBLE WITH GLASSES OF VARIOUS SIZES



The upper and lower platform positions are adjustable to accommodate two different glass heights. The guide can also be moved back and forth to fit every glass shape. The minimum height difference of/between the two platforms: 20 mm.



### MEDIUM SIZE

Glasses:  
135 - 200 mm



### LARGE SIZE

Glasses:  
155 - 240 mm

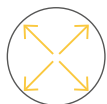

The dispenser is compatible  
with glass diameter of:

**50 - 105 MM**



### DBF-AS65WE-EU

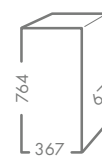

Dispensing capacity:  
65 ltr in 4hr  
(after initial freeze down period of 10hr)

Additional 10.2 ltr  
(after 45 min. recovery time)

Dispensing speed:  
34 - 49 ml/s (2.0 - 3.5 bar)

Reference 1. Source: BAR BUSINESS magazine Sept 2016, article '7 wasteful sins: How You're Losing Profit on Draft Beer Sales'

SPECIALTY

SPECIALTIES  
FROM HOSHIZAKI

## HOSHIZAKI EQUIPMENT REALLY IS BUILT TO LAST!

Two Hoshizaki sushi cases are sited in prime position on the sushi bar at Matsuri, a Japanese fine dining restaurant situated in the heart of London's Mayfair.

Since the restaurant opened in 1993, Hoshizaki sushi cases have been in daily use. Manager Cristoforo Santini explains; "I believe the first sushi case we had lasted for 10 or 12 years and was replaced with one of the pair we're using now" – Hoshizaki equipment really is built to last!

*"The display cabinets have certainly attracted customers"*

**Cristoforo Santini**

Manager Japanese fine dining restaurant Matsuri in London

A display case will generally come in two types of refrigeration: gravity coil and forced air.

With the Hoshizaki display cases you avoid the drying effect on uncovered food of forced air refrigeration. Cold air is simply 'dropped' over the food and chills it – the preferred option for salads, meat, seafood and sushi.



# GOOD FOOD COMES FROM FRESH INGREDIENTS

## PROUDLY DISPLAY YOUR FRESH FISH, MEAT AND PERISHABLE PRODUCTS

Our line of refrigerated display cases combine innovative features with a modern and elegant design, and are configured to highlight and preserve the freshness of even the most delicate fish types.

The range is designed to maintain the most natural level of humidity and food-safe temperatures, even during peak serving times with frequent door openings.

The smooth and diffused airflow works without any forced air circulation. This method creates ideal conditions avoiding unpleasant dehydration and weight loss of the stored goods.

### SIMPLE IS SMART

One of the strikingly simple solutions for easy and fast temperature control: The inside tray can be flipped face up or face down to set the perfect inside temperature for different types of fish.

The elevated side wings of the trays allow more air circulation, lowering the storage temperature instantly.

**Tray facing up:** More delicate fish types.

**Tray facing down:** Fish types that require lower storage temperatures.

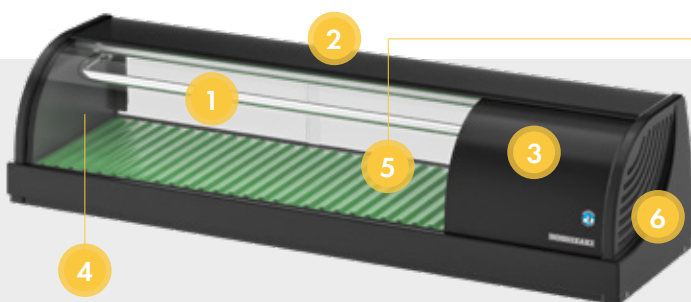

1. | Tubular-shaped evaporator absorbs the heat continuously  
Condensation freezes on its external surface, maintaining an attractive frost layer with no dripping
2. | Practical anti-slip top: ideal to place serving dishes
3. | Sliding door with 150 mm height, easily disassembled and removed for daily cleaning
4. | Curved glass for optimal visibility of the displayed food. With anti-scattering film for glass splinter protection
5. | Lightweight ABS trays with a wave-shaped profile, removable for easy cleaning
6. | The **condensing unit** of all our models sit either on the right- or left-hand side, with the outflow of air positioned on the sides away from the operator



# SPECIALTIES

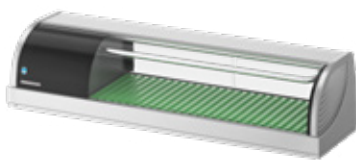

**HNC-120BE**

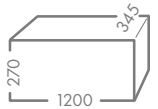

Net capacity: 42 litres  
Average temperature: 3°C

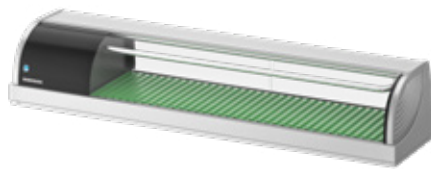

**HNC-150BE**

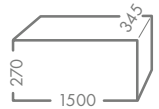

Net capacity: 57 litres  
Average temperature: 3°C

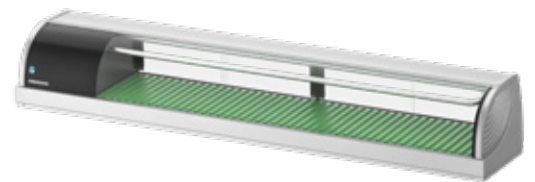

**HNC-180BE**

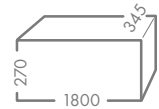

Net capacity: 72 litres  
Average temperature: 3°C

Refrigerated display cases are also available with 2100 mm width



All models are available in either black or steel finish, and with the choice of having the condensing unit on the right- or left-hand side.

For all models: Electrical supply: 1/220 -240/50Hz - Electrical consumption 0.15 (kW)

## COOKING EACH RICE GRAIN TO PERFECTION

**TIGER** This automatic rice-cooker produces up to 40 cups of rice, with the ability to keep the rice warm for 12 hours. Additionally, the thermal warmers are able to preserve the rice up to 6 hours at serving temperature without using any electricity, while preserving its just-cooked texture.



**JNO-B36W RICE COOKER**



Cooking capacity: 3.6 l  
\* incl. handles  
Height, lid opened: 720 mm



**JFM-390P/570P THERMAL HEATING**



Capacity: 3.9 / 5.7 l  
\* incl. handles



**LEADING NATURALLY**

# OUR BRANCH OFFICES

## HOSHIZAKI EUROPE B.V. - HQ

Burgemeester Stramanweg 101  
1101AA Amsterdam  
Noord-Holland  
The Netherlands  
T. +31 (0)20 6918499  
E. sales@hoshizaki.nl

## UK OFFICE

2 The Technology Centre  
London Road  
Swanley, Kent BR8 7AG  
United Kingdom  
T. +44 (0)845 456 0585  
E. uksales@hoshizaki.uk

## BUREAU FRANÇAIS

Paris Nord II, 13 Rue De La Perdrix  
BP 44072 Tremblay En France  
95913 Roissy Charles De Gaulle Cedex  
France  
T. +33 (0)1 48 63 93 80  
E. info@hoshizaki.fr

## BÜRO DEUTSCHLAND

Kampstrasse 16  
D-31180 Giesen-Hasede  
Deutschland  
T. +49 (0)5121 697370  
E. vertrieb@hoshizaki.de

## BÜRO DEUTSCHLAND

Halskestrasse 17  
47877 Willich-Munchheide III  
Deutschland  
T. +49 (0)2154 92810  
E. vertrieb@hoshizaki.de

## BENELUX OFFICE

Twentepoort West 62  
7609 RD Almelo  
Nederland  
T. +31 (0)85 0188370  
E. info@hoshizaki.nl

## OFICINA DE IBERIA (ESPAÑA & PORTUGAL)

Edificio Bruselas, Bajo 1º  
Ctra. de l'Hospitalet 147-149  
08940 Cornellá de Llobregat  
Barcelona – Spain  
T. +34 (0)93 478 09 52  
E. info@hoshizaki.es

## MIDDLE EAST OFFICE

Jafza One Tower B  
P.O. Box 261761  
Office 1215  
Jebel Ali Free Zone  
Dubai, United Arab Emirates  
T. +971 (0)48 876 612  
E. sales@hoshizaki.ae

## HOSHIZAKI - EXPORT

Burgemeester Stramanweg 101  
1101AA Amsterdam  
Noord-Holland  
The Netherlands  
T. +31 (0)20 6918499  
E. sales@hoshizaki.nl

## SALG DANMARK

Aage Grams vej 1  
6500 Vojens  
Danmark  
T. +45 8988 5360  
E. info@hoshizaki.dk  
E. salg@hoshizaki.dk

## SALG NORGE

Pb. 2126  
3103 Tønsberg  
Norge  
T. +47 22 88 17 50  
E. Salg@hoshizaki.no

## FÖRSÄLJNING SVERIGE

Box 5157  
200 71 Malmö  
Sverige  
T. +46 108 84 87 47  
E. orderSE@hoshizaki.dk

## FILIALE ITALIANA

Sede Legale:  
P.za S.Maria Beltrade, 1  
20123 Milano  
Italia  
T. +39 348 302 2156  
E. info@hoshizaki.it



**HOSHIZAKI** | **GRAM**

## BUILT ON STRONG FOUNDATIONS

Hoshizaki has earned an international reputation for pioneering innovation in kitchen and food service equipment solutions. By merging with refrigeration specialist Gram Commercial, we have brought together the brilliance of Japanese engineering and the intelligence of Danish design. Our collaboration has created the world's most connected, innovative and responsible manufacturer of cold solutions.

**Together, we continue to explore the realms of possibility.**

### Hoshizaki UK

2 The Technology Centre  
London Road  
Swanley, Kent BR8 7AG  
United Kingdom  
T. +44 (0)845 456 0585

[uksales@hoshizaki.uk](mailto:uksales@hoshizaki.uk)  
[www.hoshizaki.uk](http://www.hoshizaki.uk)



Every effort has been made to ensure that the information contained in this publication is accurate at the time of publishing. Hoshizaki Europe B.V. assumes no responsibility or liability for typographical errors or omissions or for any misinterpretation of the information within the publication and reserves the right to change without notice.